

# TC57

## Touch Computer



## User Guide for Android™ 8.1.0 Oreo



**ZEBRA**

---

## Copyright

ZEBRA and the stylized Zebra head are trademarks of Zebra Technologies Corporation, registered in many jurisdictions worldwide. Google, Android, Google Play and other marks are trademarks of Google LLC; Oreo is a trademark of Mondelez International, Inc. group. All other trademarks are the property of their respective owners. ©2019 Zebra Technologies Corporation and/or its affiliates. All rights reserved.

COPYRIGHTS & TRADEMARKS: For complete copyright and trademark information, go to [www.zebra.com/copyright](http://www.zebra.com/copyright).

WARRANTY: For complete warranty information, go to [www.zebra.com/warranty](http://www.zebra.com/warranty).

END USER LICENSE AGREEMENT: For complete EULA information, go to [www.zebra.com/eula](http://www.zebra.com/eula).

## Terms of Use

- Proprietary Statement

This manual contains proprietary information of Zebra Technologies Corporation and its subsidiaries (“Zebra Technologies”). It is intended solely for the information and use of parties operating and maintaining the equipment described herein. Such proprietary information may not be used, reproduced, or disclosed to any other parties for any other purpose without the express, written permission of Zebra Technologies.

- Product Improvements

Continuous improvement of products is a policy of Zebra Technologies. All specifications and designs are subject to change without notice.

- Liability Disclaimer

Zebra Technologies takes steps to ensure that its published Engineering specifications and manuals are correct; however, errors do occur. Zebra Technologies reserves the right to correct any such errors and disclaims liability resulting therefrom.

- Limitation of Liability

In no event shall Zebra Technologies or anyone else involved in the creation, production, or delivery of the accompanying product (including hardware and software) be liable for any damages whatsoever (including, without limitation, consequential damages including loss of business profits, business interruption, or loss of business information) arising out of the use of, the results of use of, or inability to use such product, even if Zebra Technologies has been advised of the possibility of such damages. Some jurisdictions do not allow the exclusion or limitation of incidental or consequential damages, so the above limitation or exclusion may not apply to you.

---

## Revision History

Changes to the original guide are listed below:

Change	Date	Description
-01 Rev A	12/2018	Initial release.
-02 Rev A	7/2019	Added note to Installing the Battery.

# Table of Contents

Copyright .....	2
Terms of Use .....	2
<b>About This Guide .....</b>	<b>12</b>
Introduction .....	12
Documentation Set .....	12
Configurations .....	12
Software Versions .....	13
Chapter Descriptions .....	13
Notational Conventions .....	13
Related Documents .....	14
Service Information .....	14
Provide Documentation Feedback .....	15
<b>Getting Started .....</b>	<b>16</b>
Introduction .....	16
Unpacking .....	16
Features .....	17
Setup .....	19
Installing a microSD Card .....	22
Installing the Battery .....	23
Charging the Battery .....	24
Charging Indicators .....	25
Google Account Setup .....	25
Zebra Visibility Services .....	25
Replacing the Battery .....	26
Replacing the microSD Card .....	27
Replacing the SIM Card .....	28
Accessing Device Settings .....	30
Battery Management .....	31

## Table of Contents

Monitoring Battery Usage .....	31
Low Battery Notification .....	32
Battery Optimization .....	32
Turning Off the Radios .....	32
Setting the Date and Time .....	32
Display Settings .....	33
Setting the Screen Brightness .....	33
Setting Screen Rotation .....	34
Setting Home Screen Rotation .....	34
Setting Screen Timeout .....	34
Setting Font Size .....	35
Ambient Display .....	36
Touch Panel Mode .....	36
Setting Notification LED .....	37
Cast .....	37
General Sound Setting .....	37
Wake-Up Sources .....	39
<b>Using the Device .....</b>	<b>41</b>
Introduction .....	41
Google Mobile Services .....	41
Home Screen .....	41
Status Bar .....	43
Status Icons .....	43
Notification Icons .....	44
Managing Notifications .....	45
Setting App Notifications .....	46
Viewing Notification Settings for All Apps .....	47
Controlling Lock Screen Notifications .....	47
Quick Access Panel .....	47
Editing Icons on Quick Settings .....	48
App Shortcuts and Widgets .....	49
Adding an App Shortcut to the Home Screen .....	49
Adding a Widget to the Home Screen .....	49
Moving Items on the Home Screen .....	50
Removing an App Shortcut or Widget from the Home Screen .....	50
Folders .....	50
Creating a Folder .....	50
Naming Folders .....	50
Removing a Folder .....	51
Home Screen Wallpaper .....	51
Using the Touchscreen .....	51

## Table of Contents

Keyboards .....	52
Editing Text .....	52
Entering Numbers, Symbols, and Special Characters .....	52
Keyboard Configuration .....	52
Enabling Keyboards .....	52
Switching Between Keyboards .....	52
Do Not Disturb Feature .....	53
Limit Sounds and Vibrations .....	53
Total Silence .....	53
Alarms Only .....	53
Automatically Block Sounds and Vibrations .....	54
Silence Sounds During Certain Times .....	54
Silence Sounds During Events and Meetings .....	54
Turn Sounds Back On .....	55
Override Do Not Disturb for Specific Apps .....	55
Apps .....	55
Accessing Apps .....	58
Switching Between Recent Apps .....	59
Un-Locking the Screen .....	60
Smart Lock .....	62
Resetting the Device .....	63
Performing a Soft Reset .....	63
Performing a Hard Reset .....	64
Suspend Mode .....	64
Transferring Files with a Host Computer via USB .....	64
Transferring Files .....	64
Transferring Photos .....	65
Disconnect from the Host Computer .....	65
<b>Calls .....</b>	<b>67</b>
Introduction .....	67
Emergency Calling .....	67
Audio Modes .....	67
Using a Bluetooth Headset .....	67
Using a Wired Headset .....	67
Adjusting Audio Volume .....	68
Making a Call Using the Dialer .....	68
Dialer Dialing Options .....	70
Making a Call Using Contacts .....	70
Using the Dialer .....	70
Using the Contacts App .....	71
Making a Conference Call on GSM .....	73

## Table of Contents

Making a Call Using a Bluetooth Headset .....	75
Answering Calls .....	75
Call Settings .....	76
<b>Applications .....</b>	<b>79</b>
Introduction .....	79
ActiveEdge Touch Zone .....	79
Configuring ActiveEdge .....	79
Selecting Apps for a Drawer .....	80
Battery Manager .....	82
Camera .....	86
Taking Photos .....	86
Taking a Panoramic Photo .....	87
Recording Videos .....	88
Photo Settings .....	89
Front Camera .....	89
Rear Camera .....	89
Video Settings .....	90
Front Camera .....	90
Rear Camera .....	91
Contacts .....	91
Adding a Contact .....	91
Editing Contacts .....	91
Deleting Contacts .....	92
Device Central .....	93
Device Central Tabs .....	94
Paging an RS6000 Ring Scanner .....	94
DataWedge Demonstration .....	96
Scanner Selection .....	97
Diagnostic Tool .....	98
Settings .....	101
Battery Test Information .....	101
GPS Test Information .....	102
System Test Information .....	102
WLAN Test Information .....	102
WWAN Test Information .....	102
Bluetooth Test Information .....	103
Files .....	104
Gallery .....	106
Working with Albums .....	108
Sharing an Album .....	108
Getting Album Information .....	108

## Table of Contents

Deleting an Album .....	109
Working with Photos .....	109
Viewing and Browsing Photos .....	109
Cropping a Photo .....	110
Setting a Photo as a Contact Icon .....	110
Sharing a Photo .....	111
Deleting a Photo .....	111
Working with Videos .....	111
Watching Videos .....	111
Sharing a Video .....	111
Deleting a Video .....	112
Photos .....	113
Working with Albums .....	114
Sharing an Album .....	115
Deleting an Album .....	115
Working with Photos .....	116
Viewing and Browsing Photos .....	116
Cropping a Photo .....	116
Setting a Photo as a Contact Icon .....	117
Sharing a Photo .....	117
Deleting a Photo .....	118
Working with Videos .....	118
Watching a Video .....	118
Sharing a Video .....	118
Deleting a Video .....	118
PTT Express Voice Client .....	119
PTT Audible Indicators .....	119
PTT Notification Icons .....	119
Enabling PTT Communication .....	121
Selecting a Talk Group .....	121
PTT Communication .....	121
Creating a Group Call .....	121
Responding with a Private Response .....	122
Disabling PTT Communication .....	122
RxLogger .....	123
RxLogger Utility .....	124
SimulScan Demo .....	125
Printing the Sample Forms .....	126
Using the Postal, Transportation and Logistics Example .....	127
Using the Manufacturing Example .....	129
Settings .....	131
Advanced Settings .....	131
Creating a Demo Customization .....	132
Default Templates .....	134

Sound Recorder .....	134
<b>Data Capture.....</b>	<b>136</b>
Introduction .....	136
Imaging .....	136
Digital Camera .....	136
Linear Imager .....	137
Operational Modes .....	137
RS507 Hands-Free Imager .....	138
RS6000 Bluetooth Ring Scanner .....	138
DS3678 Digital Scanner .....	139
LI3678 Linear Imager Scanner .....	139
DS2278 Digital Scanner .....	140
Scanning Considerations .....	140
Scanning with Internal Imager .....	140
Scanning with Internal Camera .....	142
Scanning with RS6000 Bluetooth Ring Scanner .....	143
Scanning with RS507/RS507X Hands-Free Imager .....	144
Scanning with the DS3608 USB Scanner or DS3678 Bluetooth Scanner .....	146
Scanning with LI3678 Linear Imager .....	147
Scanning with DS2278 Digital Scanner .....	147
Pairing the RS507/RS6000 Hands-Free Imager .....	148
Pairing in SSI Mode Using Near Field Communication .....	148
Pairing in HID Mode Using Near Field Communication .....	149
Pairing Using Simple Serial Interface .....	150
Pairing Using Bluetooth Human Interface Device .....	151
Pairing a Bluetooth Scanner .....	152
Pairing Using Simple Serial Interface .....	152
Pairing Using Bluetooth Human Interface Device .....	154
DataWedge .....	154
Enabling DataWedge .....	154
Disabling DataWedge .....	155
<b>Wireless .....</b>	<b>156</b>
Introduction .....	156
Wireless Wide Area Networks .....	156
Sharing the Mobile Data Connection .....	156
Enabling USB Tethering .....	156
Enabling Bluetooth Tethering .....	157
Configuring the Wi-Fi Hotspot .....	157



## Table of Contents

Enabling Wi-Fi Hotspot .....	158
Configuring the Wi-Fi Hotspot .....	158
Cellular Network Settings .....	159
Disabling Data When Roaming .....	159
GSM Devices .....	160
Enhanced 4G LTE Mode .....	160
Using Search for MicroCell .....	161
Using System Select .....	161
Configuring the Access Point Name .....	161
Locking the SIM Card .....	161
Data Usage .....	162
Setting Data Usage Warning .....	163
Setting Data Limit .....	163
Wireless Local Area Networks .....	164
Connecting to a Wi-Fi Network .....	164
Removing a Wi-Fi Network .....	165
Bluetooth .....	165
Adaptive Frequency Hopping .....	166
Security .....	166
Bluetooth Profiles .....	167
Bluetooth Power States .....	168
Bluetooth Radio Power .....	168
Enabling Bluetooth .....	168
Disabling Bluetooth .....	168
Discovering Bluetooth Device(s) .....	168
Changing the Bluetooth Name .....	169
Connecting to a Bluetooth Device .....	169
Unpairing a Bluetooth Device .....	169
Near Field Communications .....	169
Reading NFC Cards .....	170
Sharing Information Using NFC .....	170
<b>Accessories.....</b>	<b>172</b>
Introduction .....	172
Accessories .....	172
Charging the Device .....	176
Inserting a Device with Rugged Boot into Cradle .....	177
Battery Charging .....	178
Charging Temperature .....	178
Charging the Device .....	179
Inserting a Device with Rugged Boot into Cradle .....	181
Battery Charging .....	181

## Table of Contents

Main Battery Charging .....	181
Spare Battery Charging .....	181
Charging Temperature .....	182
5-Slot Charge Only Cradle .....	183
Charging the Device .....	183
Inserting a Device with Rugged Boot into Cradle .....	184
Battery Charging .....	185
Main Battery Charging .....	185
Charging Temperature .....	185
5-Slot Ethernet Cradle .....	186
Charging the Device .....	186
Inserting a TC57 with Rugged Boot into Cradle .....	187
Battery Charging .....	188
Main Battery Charging .....	188
Charging Temperature .....	188
Establishing Ethernet Connection .....	188
LED Indicators .....	188
4-Slot Battery Charger .....	189
Charging Spare Batteries .....	189
Battery Charging .....	190
Spare Battery Charging .....	190
Charging Temperature .....	190
Rugged Boot .....	191
Installation .....	191
Installing Stylus .....	192
Charging with Cradles .....	193
2.5 mm Audio Adapter .....	195
3.5 mm Audio Adapter .....	196
Rugged Charge/USB Cable .....	198
Connecting to TC57 .....	198
Connecting to TC57 with Rugged Boot .....	199
USB Communication .....	200
Charging the Device .....	200
Disconnecting the Rugged Charge/USB Cable .....	201
Battery Charging .....	202
Main Battery Charging .....	202
Charging Temperature .....	203
Power Supply .....	204
Trigger Handle .....	205
Installing the Rugged Boot .....	205
Installing the Optional Lanyard .....	207
Inserting the Device into the Trigger Handle .....	208
Removing the Device from the Trigger Handle .....	209

<b>Maintenance and Troubleshooting .....</b>	<b>211</b>
Introduction .....	211
Maintaining the Device .....	211
Display Best Practices .....	211
Image Retention .....	211
Battery Safety Guidelines .....	212
Cleaning Instructions .....	212
Approved Cleanser Active Ingredients .....	212
Harmful Ingredients .....	213
Device Cleaning Instructions .....	213
Special Cleaning Notes .....	213
Cleaning Materials Required .....	213
Cleaning Frequency .....	214
Cleaning the Device .....	214
Housing .....	214
Display .....	214
Camera and Exit Window .....	214
Connector Cleaning .....	214
Cleaning Cradle Connectors .....	215
Troubleshooting .....	216
Device .....	216
<b>Technical Specifications .....</b>	<b>219</b>
Introduction .....	219
TC57 .....	219

**Index**

# About This Guide

## Introduction

This guide provides information about using the device mobile computer and accessories.



**NOTE:** Screens and windows pictured in this guide are samples and can differ from actual screens.

## Documentation Set

The documentation set for the device provides information for specific user needs, and includes:

- TC57 Touch Computer Quick Start Guide - describes how to get the device up and running.
- TC57 Touch Computer User Guide for Android 8.1.0 Oreo - describes how to use the device.
- TC57 Touch Computer Integrator Guide for Android 8.1.0 Oreo - describes how to set up the device and accessories.

## Configurations

This guide covers the following configurations:

Configuration	Radios	Display	Memory	Data Capture Options	Operating System
TC57HO-1	WLAN: 802.11 a/b/g/n/ac/d/h/i/r/k /v <sup>3</sup> /w WPAN: Bluetooth v5.0 Low Energy WWAN: HSPA+/LTE/CDMA	5.0" High Definition (1280 x 720) LCD	4 GB RAM / 32 GB Flash	2D imager (SE-4710) and integrated NFC	Google™ Mobile Services (GMS) 8.1.0.
TC57HO-2	WLAN: 802.11 a/b/g/n/ac/d/h/i/r/k /v <sup>3</sup> /w WPAN: Bluetooth v5.0 Low Energy WWAN: HSPA+/LTE	5.0" High Definition (1280 x 720) LCD	4 GB RAM / 32 GB Flash	2D imager (SE-4710) and integrated NFC	Android Open Source Project (AOSP) 8.1.0 (China only).

## Software Versions

To determine the current software versions:

1. Swipe down from the Status bar to open the Quick Settings bar.
2. Touch **⚙️ > System**.
3. Touch **About phonetablet**.
4. Scroll to view the following information:
  - **Model**
  - **Android version**
  - **Android security patch version**
  - **Baseband version**
  - **Kernel version**
  - **Build number**.

To determine the device serial number, touch **About phone > Status**.

- **Serial number**

## Chapter Descriptions

Topics covered in this guide are as follows:

- [Getting Started](#) provides information on getting the device up and running for the first time.
- [Using the Device](#) provides information for operating the device.
- [Calls](#) provides instructions for making phone calls.
- [Applications](#) provides information on using applications installed on the device.
- [Data Capture](#) provides information for capturing bar code data using the imager.
- [Wireless](#) provides information on the various wireless options.
- [Accessories](#) provides information for using the accessories for the device.
- [Maintenance and Troubleshooting](#) includes instructions on cleaning and provides troubleshooting solutions for potential problems during device operation.
- [Technical Specifications](#) provides the technical specifications for the device.

## Notational Conventions

The following conventions are used in this document:

- Tablet refers to the Zebra ET51 or ET56 tablet.
- **Bold** text is used to highlight the following:
  - Dialog box, window and screen names
  - Drop-down list and list box names
  - Check box and radio button names
  - Icons on a screen
  - Key names on a keypad
  - Button names on a screen.

- Bullets (•) indicate:
  - Action items
  - Lists of alternatives
  - Lists of required steps that are not necessarily sequential.
- Sequential lists (for example, those that describe step-by-step procedures) appear as numbered lists.

## Related Documents

- TC57 Touch Computer Quick Start Guide, p/n MN-003234-xx.
- TC57 Touch Computer Regulatory Guide, p/n MN003251-xx.
- TC57 Touch Computer Integrator Guide for Android 8.1.0 Oreo, p/n MN-003232-xx.
- RS507 Hands-free Imager Product Reference Guide, p/n 72E-12082-xx.
- DS36X8 Product Reference Guide, p/n MN-002689-xx.
- RS6000 User Guide, MN-002704-xx.

For the latest version of this guide and all guides, go to: [www.zebra.com/support](http://www.zebra.com/support).

## Service Information

If you have a problem with the equipment, contact Customer Support in the region. Contact information is available at: [www.zebra.com/support](http://www.zebra.com/support).

When contacting support, please have the following information available:

- Serial number of the unit (found on manufacturing label)
- Model number or product name (found on manufacturing label)
- Software type and version number
- IMEI number.

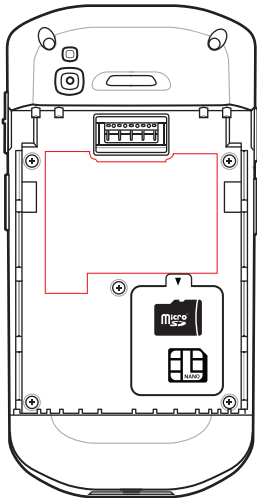

Customer Support responds to calls by email or telephone within the time limits set forth in support agreements.

If the problem cannot be solved by Customer Support, the user may need to return the equipment for servicing and will be given specific directions. We are not responsible for any damages incurred during shipment if the

approved shipping container is not used. Shipping the units improperly can possibly void the warranty. Remove the SIM card and/or microSD card from the device before shipping for service.

If the device was purchased from a business partner, contact that business partner for support.

## Provide Documentation Feedback

If you have comments, questions, or suggestions about this guide, send an email to [EVM-Techdocs@zebra.com](mailto:EVM-Techdocs@zebra.com).

# Getting Started

## Introduction

This chapter provides information for getting the device up and running for the first time.

## Unpacking

1. Carefully remove all protective material from the device and save the shipping container for later storage and shipping.
2. Verify that the following were received:
  - touch computer
  - 4,150 mAh (typical) / 3,840 mAh (minimum), 15.89 Wh PowerPrecision+ Lithium-ion battery
  - Regulatory Guide.
3. Inspect the equipment for damage. If any equipment is missing or damaged, contact the Global Customer Support center immediately.
4. Prior to using the device for the first time, remove the protective shipping film that covers the scan window, display and camera window.



## Features

Figure 1 Front View

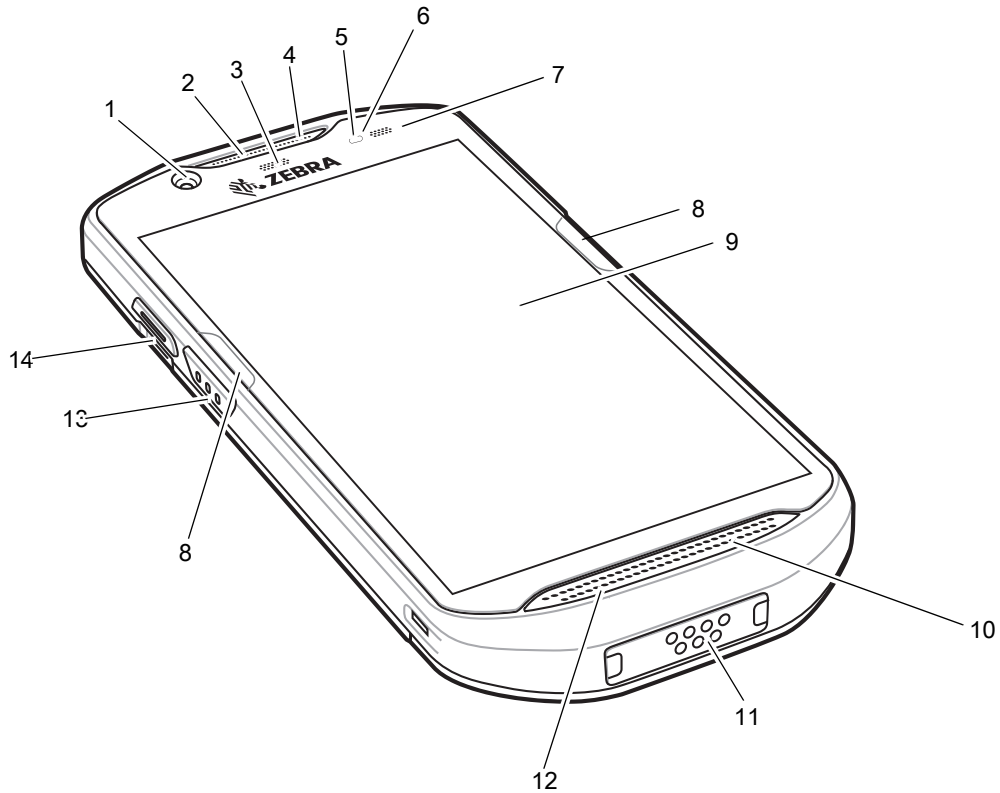

Table 1 Front View Features

Number	Item	Function
1	Front Camera	Takes photos and videos.
2	Receiver	Use for audio playback in Handset mode.
3	Data Capture LED	Indicates data capture status.
4	Microphone	Use for communications in Speakerphone mode.
5	Proximity Sensor	Determines proximity for turning off display when in handset mode.
6	Light Sensor	Determines ambient light for controlling display backlight intensity.
7	Charging/Notification LED	Indicates battery charging status while charging and application generated notifications.
8	ActiveEdge Touch Zone	Programmable dynamic soft key positioned near the perimeter of the display for one-touch access to a frequently used application or function.
9	Touch Screen	Displays all information needed to operate the device.
10	Speaker	Provides audio output for video and music playback. Provides audio in speakerphone mode.

*Table 1 Front View Features (Continued)*

Number	Item	Function
11	Interface Connector	Provides USB host and client communications, audio and device charging via cables and accessories. CAUTION: Do not remove the interface connector to ensure proper device sealing.
12	Microphone	Use for communications in Handset mode.
13	Scan Button	Initiates data capture (programmable).
14	PTT Button	Initiates push-to-talk communications (programmable).

**Figure 2 Rear View**

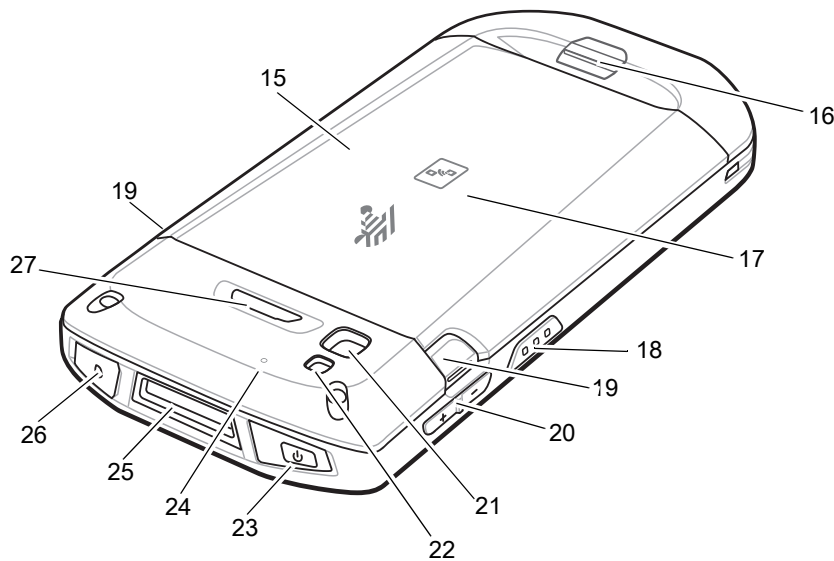

*Table 2 Back View Features*

Number	Item	Function
15	Battery	
16	Basic Hand Strap Mount	Provides mounting point for Basic Hand Strap accessory.
17	NFC Antenna	Provides communication with other NFC-enabled devices.
18	Scan Button	Initiates data capture (programmable).
19	Battery Release Latches	Press to remove the battery.
20	Volume Up/Down Button	Increase and decrease audio volume (programmable).
21	Rear Camera	Takes photos and videos.
22	Camera Flash	Provides illumination for the camera.
23	Power Button	Turns the display on and off. Press and hold to reset the device, power off or swap battery.
24	Microphone	Use for noise cancellation.

Table 2 Back View Features (Continued)

Number	Item	Function
25	Exit Window	Provides data capture using the imager.
26	Headset Jack	For audio output to headset.
27	Programmable Button	Programmable.

## Setup

Perform this procedure to start using the device for the first time.

1. Install a micro secure digital (SD) card (optional).
2. Installing a nano SIM card (optional)
3. Install hand strap (optional).
4. Install the battery.
5. Charge the device.
6. Power on the device.

### Installing the SIM Card



**NOTE:** Only use a nano SIM card.



**CAUTION:** For proper electrostatic discharge (ESD) precautions to avoid damaging the SIM card. Proper ESD precautions include, but not limited to, working on an ESD mat and ensuring that the user is properly grounded.

1. Remove access cover.

**Figure 3** Remove Access Door

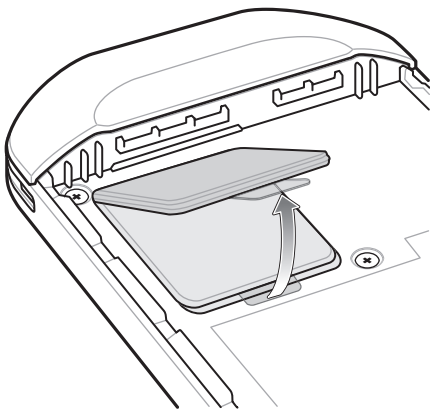

2. Slide the SIM card holder to the unlock position.

**Figure 4** Unlock SIM Card Holder

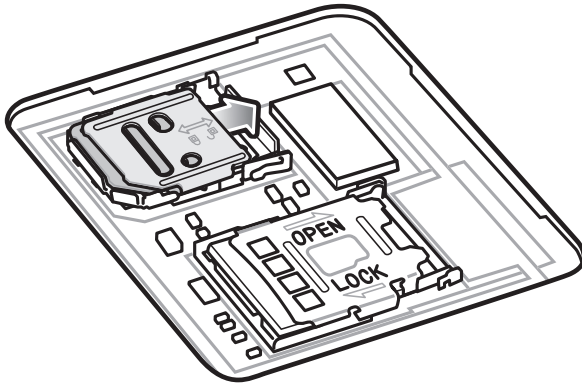

3. Lift the SIM card holder door.

**Figure 5** Lift the SIM Card Holder

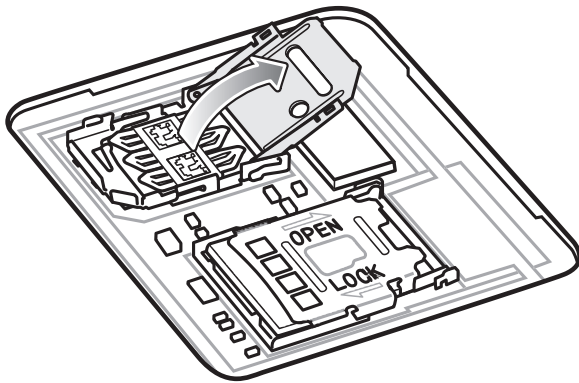

4. Place the nano SIM card into the card holder with contacts facing down.

**Figure 6** Place SIM Card in Holder

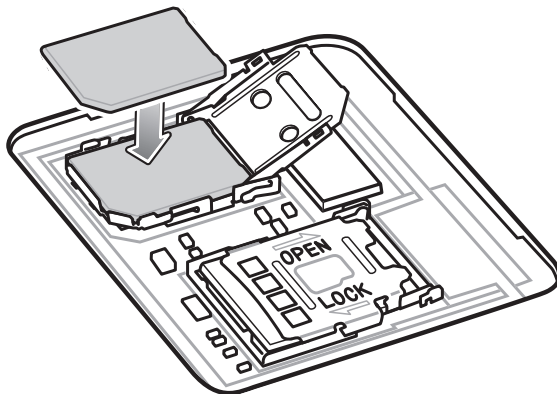

5. Close the SIM card holder door.

**Figure 7** Close SIM Card Holder Door

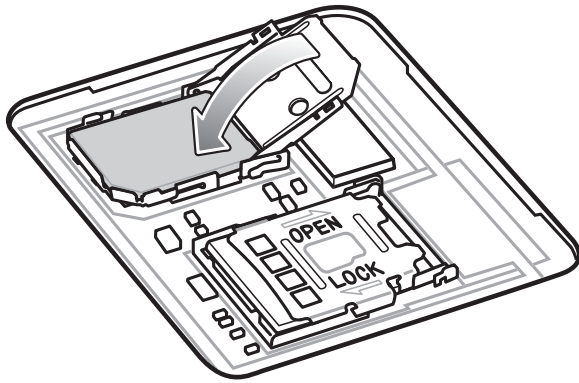

6. Slide to SIM card holder door to the lock position.

**Figure 8** Lock SIM Card Holder Door

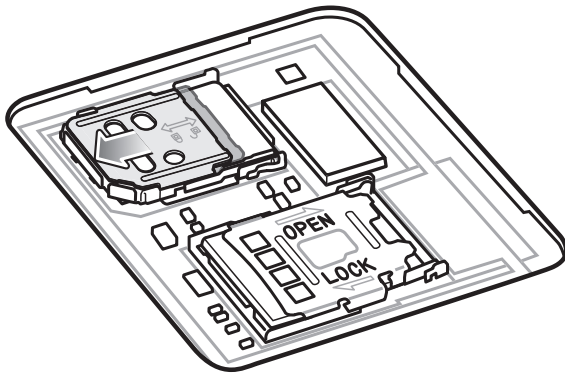

**CAUTION:** Access door must be replaced and securely seated to ensure proper device sealing.

7. Re-install the access door.

**Figure 9** Replace Access Door

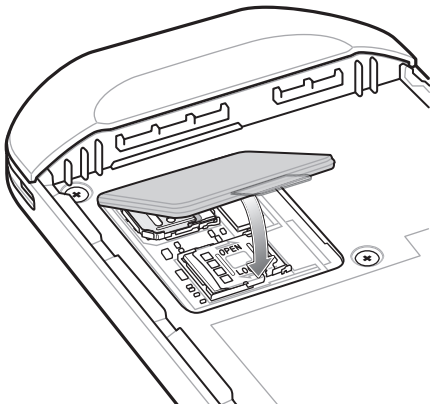

## Installing a microSD Card

The microSD card slot provides secondary non-volatile storage. The slot is located under the battery pack. Refer to the documentation provided with the card for more information, and follow the manufacturer's recommendations for use.



**CAUTION:** Follow proper electrostatic discharge (ESD) precautions to avoid damaging the microSD card. Proper ESD precautions include, but are not limited to, working on an ESD mat and ensuring that the operator is properly grounded.

1. Lift the access door.

**Figure 10** Lift Access Door

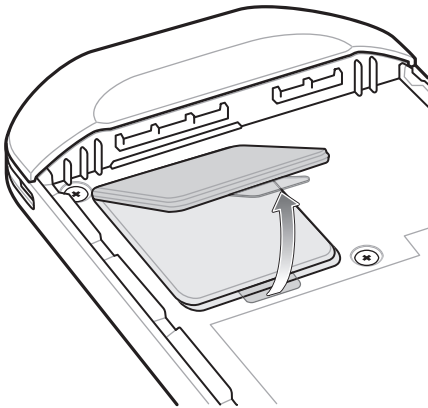

2. Slide the microSD card holder to the unlock position.

**Figure 11** Unlock microSD Card Holder

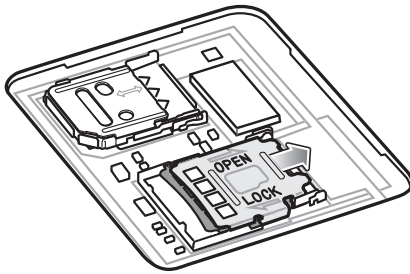

3. Lift the microSD card holder.

**Figure 12** Lift the microSD Card Holder

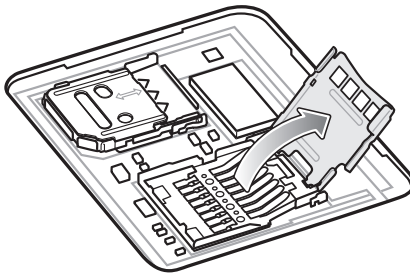

4. Insert the microSD card into the card holder door ensuring that the card slides into the holding tabs on each side of the door.

**Figure 13** Insert microSD Card in Holder

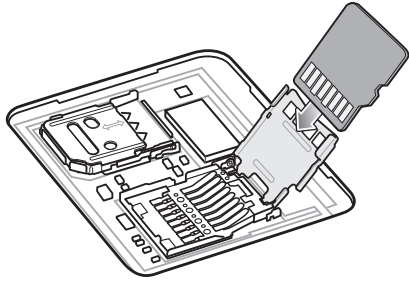

5. Close the microSD card holder and slide into the lock position.

**Figure 14** Re-install Access Door

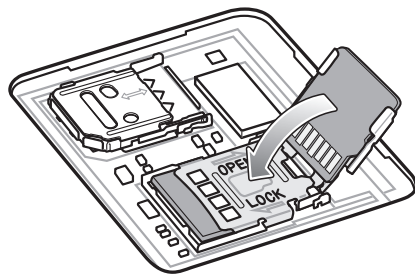

**CAUTION:** Access door must be replaced and securely seated to ensure proper device sealing.

6. Re-install the access door.

**Figure 15** Replace Access Door

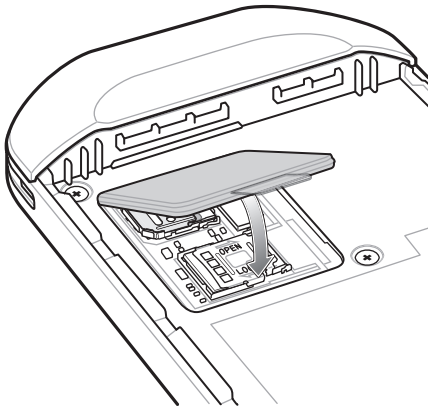

## Installing the Battery



**NOTE:** User modification of the device, particularly in the battery well, such as labels, asset tags, engravings, stickers, etc., may compromise the intended performance of the device or accessories. Performance levels such as sealing (Ingress Protection (IP)), impact performance (drop and tumble), functionality, temperature resistance, etc. could be effected. DO NOT put any labels, asset tags, engravings, stickers, etc. in the battery well.

1. Insert the battery, bottom first, into the battery compartment in the back of the device.

**Figure 16** Insert Bottom of Battery into Battery Compartment

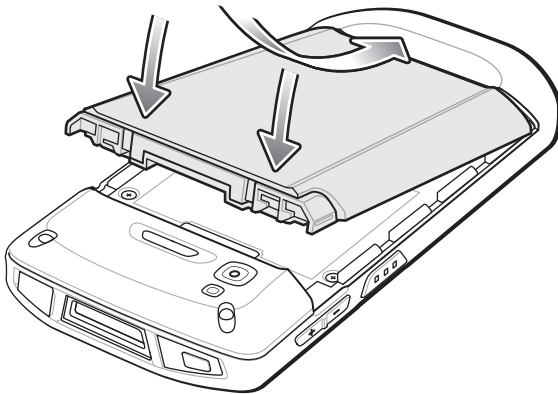

2. Press the battery down into the battery compartment until the battery release latches snap into place.

## Charging the Battery

Before using the device for the first time, charge the main battery until the green Charging/Notification light emitting diode (LED) remains lit. To charge the device use a cable or a cradle with the appropriate power supply. For information about the accessories available for the device see [Accessories](#) for more information.

The battery charges from fully depleted to 90% in approximately 2.5 hours and from fully depleted to 100% in approximately three hours.



**NOTE:** In many cases the 90% charge provides plenty of charge for daily use. A full 100% charge lasts for approximately 14 hours of use.

To achieve the best fast charging results use only Zebra charging accessories and batteries. Charge batteries at room temperature with the device in sleep mode.

Charge batteries in temperatures from 5°C to 40°C (°F to 104°F). The device or accessory always performs battery charging in a safe and intelligent manner. At higher temperatures (e.g. approximately +37°C (+98°F)) the device or accessory may for small periods of time alternately enable and disable battery charging to keep the battery at acceptable temperatures. The device or accessory indicates when charging is disabled due to abnormal temperatures via its LED and a notification appears on the display.







To charge the main battery:

1. Connect the charging accessory to the appropriate power source.
2. Insert the device into a cradle or attach to a cable. The device turns on and begins charging. The Charging/Notification LED blinks amber while charging, then turns solid green when fully charged.



## Charging Indicators

**Table 3** Charging/Notification LED Charging Indicators

State	LED	Indication
Off		Device is not charging. Device is not inserted correctly in the cradle or connected to a power source. Charger/cradle is not powered.
Slow Blinking Amber (1 blink every 4 seconds)		Device is charging.
Slow Blinking Red (1 blink every 4 seconds)		Device is charging but the battery is at end of useful life.
Solid Green		Charging complete.
Solid Red		Charging complete but the battery is at end of useful life.
Fast Blinking Amber (2 blinks/second)		Charging error, e.g.: <ul style="list-style-type: none"> <li>• Temperature is too low or too high.</li> <li>• Charging has gone on too long without completion (typically eight hours).</li> </ul>
Fast Blinking Red (2 blinks/second)		Charging error but the battery is at end of useful life., e.g.: <ul style="list-style-type: none"> <li>• Temperature is too low or too high.</li> <li>• Charging has gone on too long without completion (typically eight hours).</li> </ul>

## Google Account Setup



**NOTE:** You must connect the device to the internet in order to set up a Google™ account. A Google account is only required on devices with GMS software.

The first time the device starts, the Setup Wizard displays. Follow the on-screen instructions to set up a Google account, configure Google Pay™ for purchasing items from the Google Play™ store, to enter your personal information, and enable backup or restore features.

## Zebra Visibility Services

The device captures and provides device analytics to a system administrator. The first time the device boots (or after a Factory reset), the **Zebra Services** agreement screen displays.

Figure 17 Zebra Services

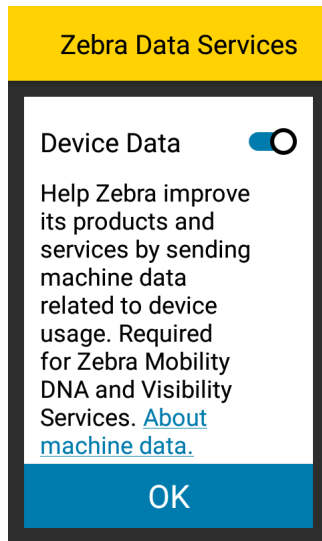

1. Touch the **Device Data** switch to disable the device from sending analytics data.
2. Touch **OK**.

## Replacing the Battery



**CAUTION:** Do not add or remove microSD card during battery replacement.

1. Press the Power button until the menu appears.
2. Touch **Battery Swap**.
3. Follow the on-screen instructions.



**WARNING:** Do not remove the battery until after the red LED completely turns off. Loss of data may result.

4. Wait for the red LED to completely turn off.
5. If hand strap is attached, remove hand strap.
6. Press the two battery latches in.

**Figure 18** Press Battery Latches

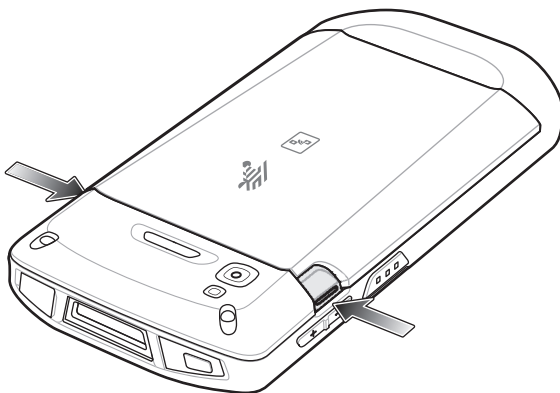

7. Lift the battery from the device.

**Figure 19** Lift the Battery

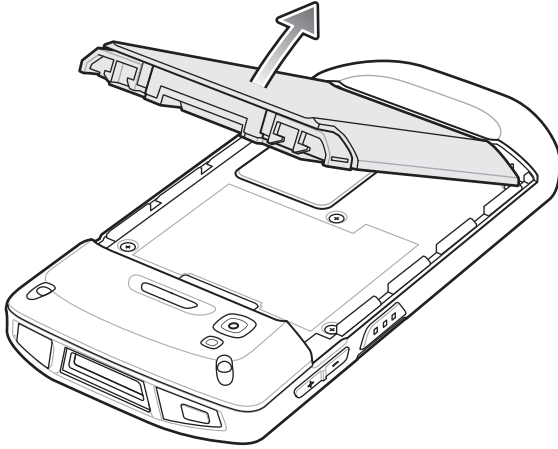

**CAUTION:** Replace the battery within 75 seconds. After 75 seconds the device reboots and data may be lost.

8. Insert the replacement battery, bottom first, into the battery compartment in the back of the device.
9. Press the battery down until the battery release latches snap into place.
10. Replace the hand strap, if required.
11. Press the Power button to turn on the device.

## Replacing the microSD Card

To replace the microSD card:

1. Press the Power button until the menu appears.
2. Touch **Power off**.
3. Touch **OK**.
4. If hand strap is attached, slide the hand strap clip up toward the top of the device and then lift.
5. Press the two battery latches in.
6. Lift the battery from the device.
7. Lift the access door.

**Figure 20** Remove Access Door

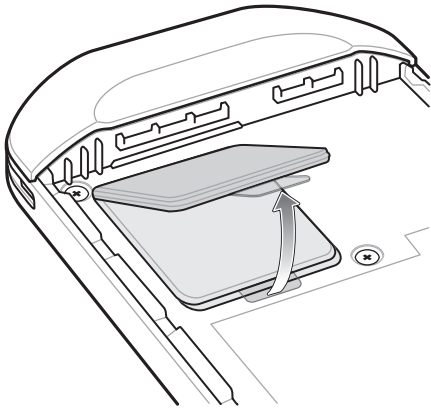

8. Remove microSD card from holder.
9. Insert the replacement microSD card.



**CAUTION:** Access door must be replaced and securely seated to ensure proper device sealing.

10. Replace the access door.

**Figure 21** Replace Access Door

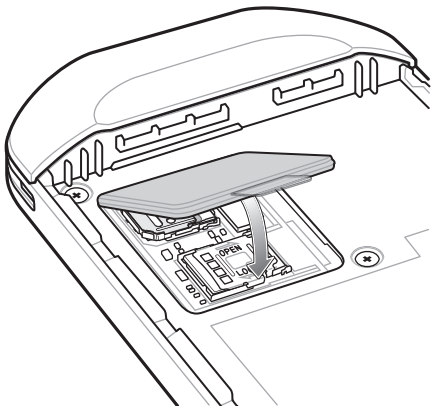

11. Insert the battery, bottom first, into the battery compartment in the back of the device.
12. Press the battery down until the battery release latches snap into place.
13. Replace the hand strap, if required.
14. Press and hold the Power button to turn on the device.

## Replacing the SIM Card

To replace the SIM card:

1. Press the Power button until the menu appears.
2. Touch **Power off**.
3. Touch **OK**.
4. If hand strap is attached, slide the hand strap clip up toward the top of the device and then lift.

5. Press the two battery latches in.
6. Lift the battery from the device.
7. Lift the access door.

**Figure 22** Remove Access Door

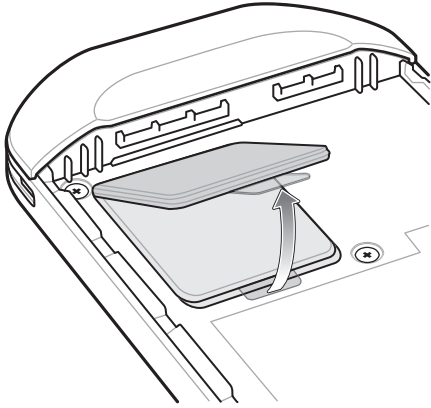

8. Slide the SIM card door to the unlock position.

**Figure 23** Unlock SIM Card Door

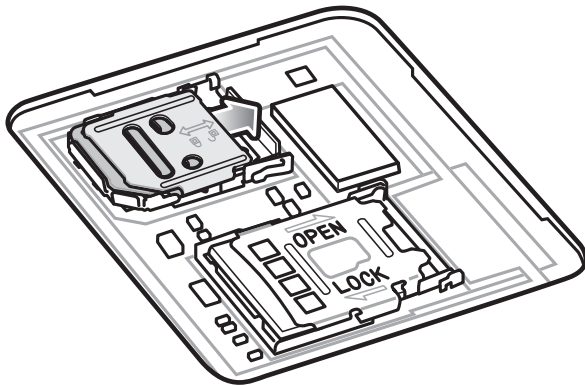

9. Lift the SIM card holder door.

**Figure 24** Lift the SIM Card Door

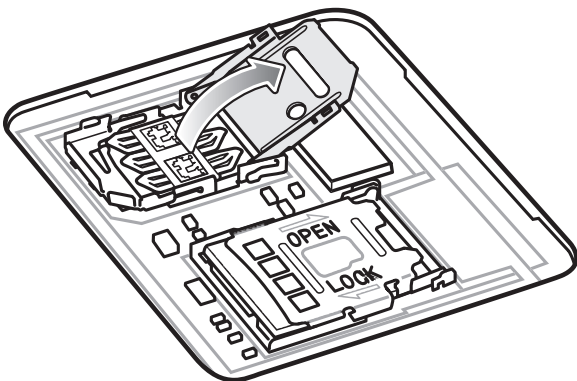

10. Remove the SIM card.

11. Place the new SIM card into the card holder with contacts facing down.

12. Close the SIM card holder.

**Figure 25** Close the SIM Card Door

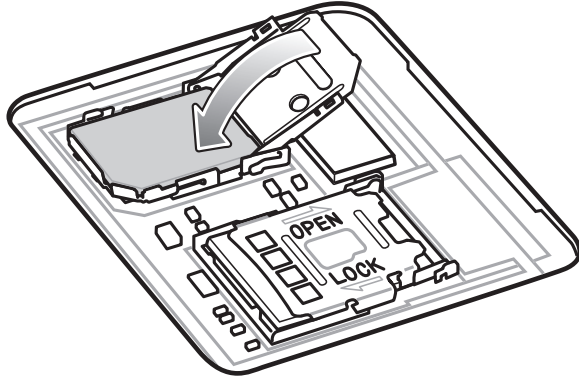

13. Slide the SIM card holder door to the lock position.



**CAUTION:** Access door must be replaced and securely seated to ensure proper device sealing.

14. Replace the access door.

**Figure 26** Replace Access Door

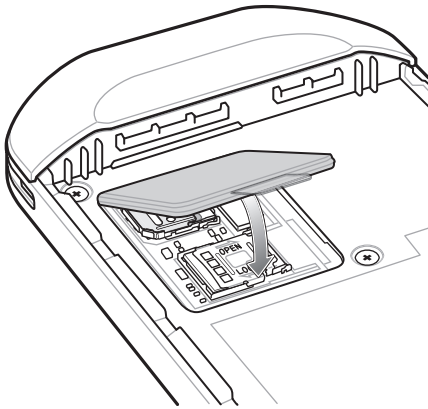

15. Insert the battery, bottom first, into the battery compartment in the back of the device.



16. Press the battery down until the battery release latch snaps into place.

17. Replace the hand strap, if required.

18. Press and hold the Power button to turn on the device.

## Accessing Device Settings

To access device settings:

1. Swipe down from the Status bar to open the Quick Settings bar and then touch .
2. On the Home screen, swipe up from the bottom of the screen and touch .

## Battery Management



**NOTE:** Prior to checking the battery charge level, remove the device from any AC power source (cradle or cable).

To check the charge status of the main battery, open **Settings** and touch **System > About phone > Battery Information**.

Alternately, swipe up from the bottom of the screen and touch  to open the **Battery Manager** app. Touch **Advanced info**. See [Battery Manager on page 66](#).

**Battery present status** indicates if the battery is present and **Battery level** lists the battery charge (as a percentage of fully charged). The battery percentage can also be viewed next to the battery icon in the quick access panel. Swipe down with two fingers from the status bar to open the quick access panel.

## Monitoring Battery Usage

The **Battery** screen provides battery charge details, power management options, and a list of apps that consume the most battery power.

Use the power management options to extend battery life, or touch an app to display details about its power consumption. Different apps display different information. Some apps include buttons that open screens with settings to adjust power use. Use the **DISABLE** or **FORCE CLOSE** buttons to turn off apps that consume too much power.

1. Swipe down from the Status bar to open the Quick Settings bar and then touch .
2. Touch **Battery**.

**Figure 27** Battery Screen

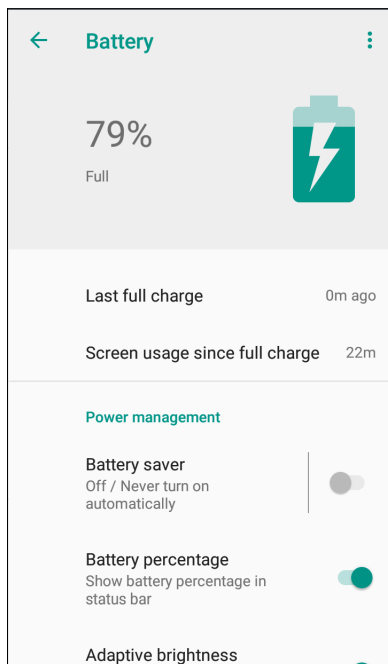

## Low Battery Notification

When the battery charge level drops below 18%, the device displays a notice to connect the device to power. The user should charge the battery using one of the charging accessories.

When the battery charge drops below 10%, the device displays a notice to connect the device to power. The user must charge the battery using one of the charging accessories.

When the battery charge drops below 4%, the device turns off. The user must charge the battery using one of the charging accessories.

**Figure 28** Low Battery Notification

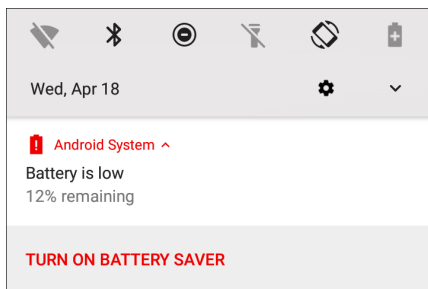

## Battery Optimization

Observe the following battery saving tips:

- Set the screen to turn off after a short period of non-use.
- Reduce screen brightness.
- Turn off all wireless radios when not in use.
- Turn off automatic syncing for Email, Calendar, Contacts, and other apps.
- Minimize use of apps that keep the device from suspending, for example, music and video apps.
- Enable Battery Saver mode. Swipe down from the Status bar and then touch **Battery saver**.
- Disable DataWedge Launcher profile. Refer to the Integrator Guide for Android 8.1.0 for this device.

## Turning Off the Radios

To turn off all the radios:

1. Swipe down from the Status bar to open the Quick Settings panel.
2. Touch **Airplane mode**. The airplane icon ✈ appears in the Status bar indicating that all the radios are off.

## Setting the Date and Time

The date and time is automatically synchronized using an NITZ server when the device is connected to a cellular network. You are only required to set the time zone or set the date and time when not connected to a cellular network or if the wireless LAN does not support Network Time Protocol (NTP).

To set the date and time:



1. Swipe down from the Status bar to open the Quick Settings bar and then touch .
2. Touch **System > Date & time**.
3. Touch **Automatic date & time** to disable automatic date and time synchronization.
4. Touch **Automatic time zone** to disable automatic time zone synchronization.
5. Touch **Set date**.
6. In the calendar, set today's date.
7. Touch **OK**.
8. Touch **Set time**.
9. Touch the green circle, drag to the current hour and then release.
10. Touch the green circle, drag to the current minute and then release.
11. Touch **AM** or **PM**.
12. Touch **OK**.
13. Touch **Select time zone**.
14. Select the current time zone from the list.
15. Touch **Use 24-hour format**.
16. Touch

## Display Settings

Use Display settings to change the screen brightness, enable night light, change the background image, enable screen rotation, set sleep time, and change font size.

### Setting the Screen Brightness

To manually set the screen brightness using the touchscreen:

1. Swipe down with two fingers from the Status bar to open the Quick Access panel.
2. Slide the icon to adjust the screen brightness level.

**Figure 29** Brightness Slider

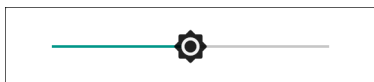

To let the device automatically adjust the screen brightness using the built-in light sensor:

1. Swipe down from the status bar to open the quick settings bar and then touch .
2. Touch **Display**.
3. If disabled, touch **Adaptive brightness** to automatically adjust the brightness.  
By default, **Adaptive brightness** is enabled. Toggle the switch to disable.
4. Touch

## Setting Screen Rotation

By default, screen rotation is enabled.

To disable screen rotation:

1. Swipe down from the Status bar to open the Quick Settings bar and then touch .
2. Touch **Display > Advanced**.
3. Touch **Auto-rotate screen**.



**NOTE:** To change the Home screen rotation, see Setting Home Screen Rotation.

4. Touch .

## Setting Home Screen Rotation

By default the **Home** screen rotation is disabled.

To enable **Home** screen rotation:

1. Touch and hold anywhere on the **Home** screen until the options appear.
2. Touch **HOME SETTINGS**.
3. Touch the **Allow Home screen rotation** switch.
4. Touch .
5. Rotate the device.

**Figure 30** Rotated Home Screen

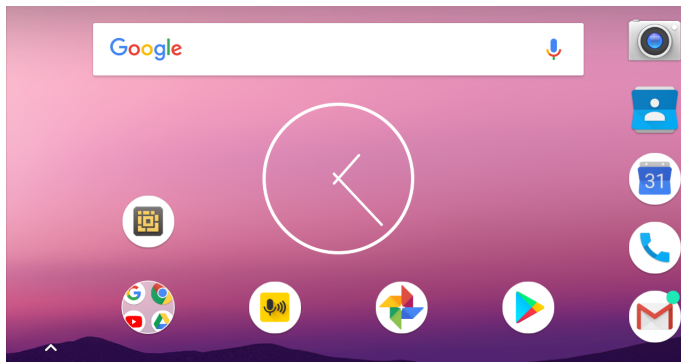

## Setting Screen Timeout

To set the screen sleep time:

1. Swipe down from the Status bar to open the Quick Settings bar and then touch .
2. Touch **Display > Advanced > Sleep**.

3. Select one of the sleep values.
  - **15 seconds**
  - **30 seconds**
  - **1 minute** (default)
  - **2 minutes**
  - **5 minutes**
  - **10 minutes**
  - **30 minutes**
4. Touch .

## Setting Font Size

To set the size of the font in system apps:

1. Swipe down from the Status bar to open the Quick Settings panel and then touch .
2. Touch **Display > Advanced**.
3. Touch **Font size**.

**Figure 31** Font Settings

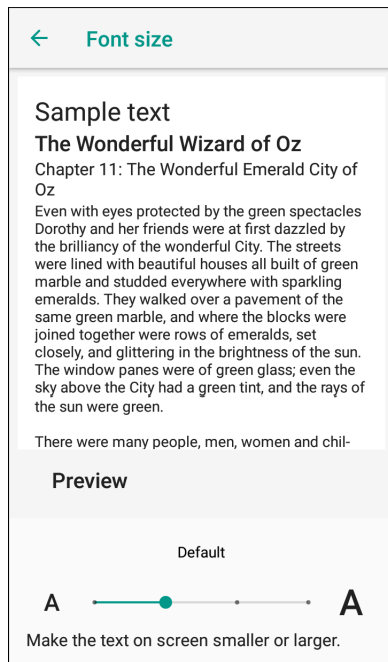

4. Select one of the font size values.
  - Small
  - Default
  - Large
  - Largest.
5. Touch .

## Ambient Display

The Ambient display setting wakes the screen when notifications are received.

To disable ambient display:

1. Swipe down from the Status bar to open the Quick Settings bar and then touch .
2. Touch **Display > Advanced**.
3. Touch **Ambient display**.
4. In the **When to show** section, enable or disable an option using the switch.
5. Touch .

## Touch Panel Mode

The device display is able to detect touches using a finger, a conductive-tip stylus, or gloved finger.



**NOTE:** A glove can be made of medical latex, leather, cotton, or wool.  
For optimal performance use a Zebra certified stylus.

1. Swipe down from the Status bar to open the Quick Settings bar and then touch .
2. Touch **Display > Advanced**.
3. Touch **Touch panel mode**.

**Figure 32** Screen Protector Mode Dialog Box

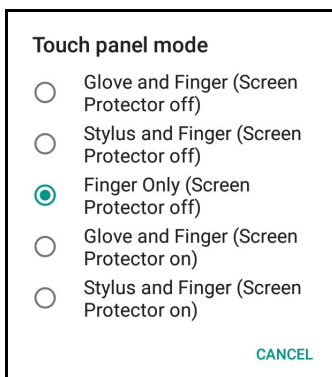



4. Select:
  - a. **Glove and Finger (Screen Protector off)** to use a finger or a gloved finger on the screen without a screen protector.
  - b. **Stylus and Finger (Screen Protector off)** to use a finger or a stylus on the screen without a screen protector.
  - c. **Finger Only (Screen Protector off)** to use a finger on the screen without a screen protector.
  - d. **Glove and Finger (Screen Protector on)** to use a finger or a gloved finger on the screen with a screen protector.

- e. **Stylus and Finger (Screen Protector on)** to use a finger or a stylus on the screen with a screen protector.
5. Touch .



## Setting Notification LED

The Charging/Notification LED lights blue when an application, such as email and VoIP, generates a programmable notification or to indicate when the device is connected to a Bluetooth device. By default, LED notifications are enabled. To change the notification setting:

1. Swipe down with two fingers from the status bar to open the quick access panel and then touch .
2. Touch **Apps & notifications > Notifications**.
3. Touch **Blink light** to toggle the notification on or off.
4. Touch .

## Cast

Use **Cast** to mirror the device screen on a Miracast enabled wireless display.

1. Swipe down from the Status bar to open the Quick Settings bar and then touch .
2. Touch **Connected Devices**.
3. Touch **Cast**.
4. Touch  > **Enable wireless display**. The device searches for nearby Miracast devices and lists them.
5. Touch a device to begin casting.
6. Touch .

## General Sound Setting

Use the **Sound** settings to configure media and alarm volumes.

To access sound settings:





1. Swipe down from the Status bar to open the Quick Settings bar and then touch .
2. Touch **Sound**.
3. Touch an option to set sounds.

Figure 33 Sound Screen

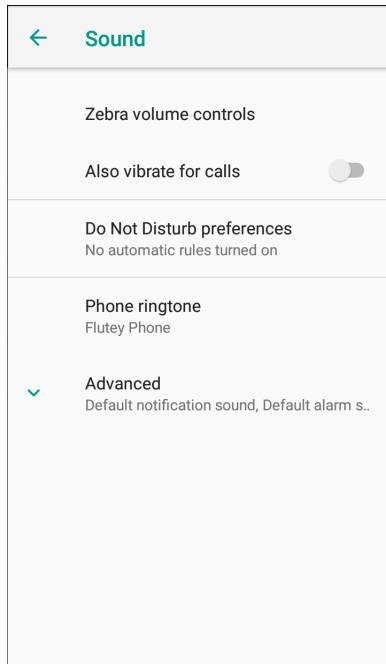

- **Zebra volume controls**
  - **Ring volume** - Controls the ringtone volume.
  - **Media volume** - Controls the music, games, and media volume.
  - **Alarm volume** - Controls the alarm clock volume.
  - **Notifications volume** - Controls the notification volume.
  - **Scanner volume** - Controls the scanner volume.
  - **Volume presets**
    -  - Mutes the ring, notifications, and scanner so that the device does not make sounds or vibrate.
    -  - All sounds except media and alarms are silenced and vibrate mode is active.
    -  - Enables all sounds at the user defined levels.
- Also vibrate for calls - Switch on or off.
- **Do Not Disturb preferences** - Mutes some or all sounds and vibrations.
  - **Priority only allows** - Use to set the priorities for the following:
    - **Reminders** - Switch on or off.
    - **Events** - Switch on or off.
    - **Alarms** - This is always enabled.
    - **Messages** - Choose to allow messages from anyone, starred contacts, any contact, or none. To star contacts, use the Contacts app.
    - **Calls** - Choose to allow calls from anyone, starred contacts, any contact, or none. To star contacts, use the Contacts app.
    - **Repeat callers** - Choose whether or not the phone rings if the same person calls again within 15 minutes.
  - **Block visual disturbances**
    - **Block when screen is on** - This option prevents notifications from displaying over the screen (peeking) while you are actively using the device.

- **Block when screen is off** - This option prevents notifications from turning on the screen or pulsing the LED light when a new notification is received while you are not using the device.
- **Automatic rules** - Choose when to automatically silence the device. Touch a default rule, such as Weekend or Weeknight, or create your own rule. To create your own rule, tap **Add more** and then **Time rule**.
- **Phone ringtone** - Touch to select a sound to play when the phone rings.
- **Advanced** - Touch to display advanced sound options.
  - **Default notification sound** - Touch to select a sound to play for all system notifications.
  - **Default alarm sound** - Touch to select a sound to play for alarms.
  - **Other sounds and vibrations**
    - **Dial pad tones** - Play a sound when pressing keys on dial pad (default - disabled).
    - **Screen locking sounds** - Play a sound when locking and unlocking the screen (default – enabled).
    - **Charging sounds** - Not applicable.
    - **Touch sounds** - Play a sound when making screen selections (default – enabled/enabled).
    - **Vibrate on tap** - Vibrate the device when making screen selections (default – disabled).
    -
  - **Emergency alerts** - Touch to configure emergency broadcast settings and notifications.

## Wake-Up Sources

By default the device wakes from suspend mode when the user presses the power button. The device can be configured to wake when the user presses the PTT or Scan buttons on the left side of the device.

1. Swipe down with two fingers from the status bar to open the quick access panel and then touch .
2. Touch **Wake-Up Sources**.
3. Touch one or more of the options:
  - Touch **SCAN** checkbox to enable the left scan button. A check appears in the checkbox.
  - Touch **RIGHT\_TRIGGER\_2** checkbox to enable the right scan button. A check appears in the checkbox.
  - Touch **LEFT\_TRIGGER\_2** checkbox to enable the PTT button. A check appears in the checkbox.
  - Touch **REAR\_BUTTON** checkbox rear programmable button. A check appears in the checkbox.

**Figure 34** Wake-Up Sources

← Wake-Up Sources	
SCAN	<input type="checkbox"/>
RIGHT_TRIGGER_1	<input type="checkbox"/>
LEFT_TRIGGER_2	<input type="checkbox"/>
REAR_BUTTON	<input type="checkbox"/>

4. Touch .



# Using the Device

## Introduction

This chapter explains the buttons, status icons, and controls on the device, and provides basic instructions for using the device including resetting the device and entering data.

## Google Mobile Services



**NOTE:** This section applies to Google Mobile Services (GMS) devices only.

Devices with GMS contain apps and services that provide additional functionality.

GMS includes:

- Apps - GMS adds a variety of Google apps and associated widgets including Chrome, Gmail, Drive, and Maps.
- Services:
  - Speech to Text - Allows for free format speech to text in many languages for both connected and disconnected network. Launch by touching the microphone icon on the keyboard.
  - TalkBack Service - Provides spoken feedback on various parts of the user interface. To enable, go to **Settings > Accessibility**.
  - Network Location Provider - Adds a location provider which uses mobile network tower information and Wi-Fi access point information to provide a location without using GPS. To enable, go to **Settings > Security & location > Location**.
  - Widevine DRM - Enables Digital Rights Management (DRM) so that protected streaming video content can be played. Enable DRM Info from the Google Play™ store.
  - Google Cloud Messaging - Allows the device to receive data from the server and other devices on the same connection.
  - Backup and Restore - Allows the users settings and apps to be backed up to a Google server and subsequently restored from that server after a factory reset.
- Google Accounts - Create and use a Google account to synchronize mail, files, music, photos, contacts and calendar events.

## Home Screen

The Home screen displays when the device turns on. Depending upon the configuration, the Home screen might appear different. Contact your system administrator for more information.

After a suspend or screen time-out, the Home screen displays with the lock sliders. Touch the screen and slide up to unlock. For screen locking information see [Un-Locking the Screen on page 53](#).

**Figure 35** Home Screen



**Table 4** Home Screen Items

Item	Description
1 — Recent Button	Displays recently used applications.
2 — Home	Displays the Home screen.
3 — Back	Displays the previous screen.
4 — Shortcut Icons	Opens applications installed on the device. See <a href="#">Application Shortcuts and Widgets on page 41</a> for more information.
5 — Widgets	Launches stand-alone applications that run on the Home screen. See <a href="#">Application Shortcuts and Widgets on page 41</a> for more information.
6 — Status Bar	Displays the time, status icons (right side), and notification icons (left side). For more information see <a href="#">Status Bar on page 36</a> and <a href="#">Managing Notifications on page 38</a> .

The Home screen provides four additional screens for placement of widgets and shortcuts. When available, swipe the screen left or right to view the additional screens. The additional screens are not viewable by default.

## Status Bar

The Status bar displays the time, notification icons (left side), and status icons (right side).



**NOTE:** Some Status icons may not appear in the Status bar if there are too many icons to display.

**Figure 36** Notification and Status Icons



If there are more notifications than can fit in the Status bar, two dots display indicating that more notifications exist. Swipe down from the Status bar to open the Notification panel and view all notifications and status.





## Status Icons

**Table 5** *Status Icons*

Icon	Description
	Alarm is active.
	Main battery is fully charged.
	Main battery is partially drained.
	Main battery charge is low.
	Main battery charge is very low.
	Main battery is charging.
	All sounds, except media and alarms, are silenced and vibrate mode is active.
	Do Not Disturb mode active.
	Airplane Mode is active. All radios are turned off.
	Bluetooth is on.
	The device is connected to a Bluetooth device.
	Connected to a Wi-Fi network.
	Not connected to a Wi-Fi network or no Wi-Fi signal.
	Connected to an Ethernet network.









<sup>1</sup>Cellular network icon that appears is dependent upon the carrier/network.

**Table 5** *Status Icons (Continued)*















Icon	Description
	Speakerphone enabled.
	Portable Wi-Fi hotspot is active (WWAN only).
	Connected to a 4G LTE/LTE-CA network (WWAN only) <sup>1</sup> .
<b>4G</b>	Connected to a DC-HSPA, HSDPA, HSPA+, HSUPA, LTE/LTE-CA or WCDMA network (WWAN only) <sup>1</sup> .
<b>3G</b>	Connected to a 1x-RTT (Sprint), EGDGE, EVDO, EVDV or WCDMA network (WWAN only) <sup>1</sup> .
<b>H</b>	Connected to a DC - HSPA, HSDPA, HSPA+ or HSUPA network (WWAN only) <sup>1</sup> .
<b>E</b>	Connected to an EDGE network (WWAN only) <sup>1</sup> .
<b>G</b>	Connected to a GPRS network (WWAN only) <sup>1</sup> .
<b>2G</b>	
<b>1X</b>	Connected to a 1x-RTT (Verizon) network (WWAN only) <sup>1</sup> .
	Roaming from a network (WWAN only).
	No SIM card installed (WWAN only).
<sup>1</sup> Cellular network icon that appears is dependent upon the carrier/network.	

## Notification Icons

**Table 6** *Notification Icons*

Icon	Description
	Main battery is low.
..	More notifications are available for viewing.
	Data is syncing.
	Indicates an upcoming event. Non-GMS devices only.
	Indicates an upcoming event. GMS devices only.
	Open Wi-Fi network is available.
	Song is playing.
	Problem with sign-in or sync has occurred.
	Device is uploading data.

**Table 6** *Notification Icons (Continued)*

Icon	Description
	Device is downloading data when animated and download is complete when static.
	Device is connected via USB cable.
	Device is connected to or disconnected from virtual private network (VPN).
	Preparing internal storage by checking it for errors.
	USB debugging is enabled on the device.
	Call is in progress (WWAN only).
	One or more voice message is in mailbox (WWAN only).
	Call is on hold (WWAN only).
	Call was missed (WWAN only).
	Headset is connected to the device.
	PTT Express Voice client status. See the PTT Express PTT Notification Icons for a complete list.
	Indicates that RxLogger app is running.
	Indicates the Bluetooth scanner is connected to the device.
	Indicates the RS507/RS507X or RS6000 is connected to the device in HID mode.

## Managing Notifications

Notification icons report the arrival of new messages, calendar events, alarms, and ongoing events. When a notification occurs, an icon appears in the Status bar with a brief description. See Notification Icons for a list of possible notification icons and their description. Open the Notification panel to view a list of all the notifications.

To open the Notification panel, drag the Status bar down from the top of the screen.

**Figure 37** Notification Panel

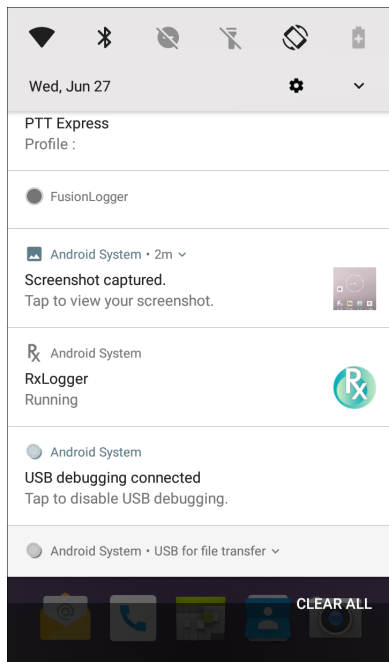

To respond to a notification, open the Notification panel and then touch a notification. The Notification panel closes and the corresponding app opens.

To clear all notifications, open the Notification panel and then touch **CLEAR ALL**. All event-based notifications are removed. Ongoing notifications remain in the list.

To close the Notification panel, swipe the Notification panel up.

## Setting App Notifications

To set notification settings for a specific app:

1. Swipe down from the Status bar to open the Quick Settings bar and then touch **⚙️**.
2. Touch **Apps & notifications > Notifications > App notifications**.
3. Select an app.
4. Select an available option:
  - **On / Off** - Select to turn all notifications from this app **On** (default) or **Off**.
  - **Allow notification dot** - Do not allow this app to add a notification dot to the app icon.
  - **Allow interruptions** - Do not allow notifications from this app to make sound, vibrate, or pop notifications on the screen.
  - **Override Do Not Disturb** - Allow these notifications to interrupt when Do Not Disturb is set to Priority Only.
  - **Categories** - Do not allow specific types of notifications from this app.
  - **Additional settings in the app** - Open the app settings.



**NOTE:** To change the notification settings for an app, slide the notification slightly left or right and touch **⚙️**.

## Viewing Notification Settings for All Apps

To view the notification settings for all apps:

1. Swipe down from the Status bar to open the Quick Settings bar and then touch .
2. Touch **Apps & Notifications**.
3. Scroll down to **Notifications** to view how many apps have notifications turned off.
4. To set or view notifications settings for a specific app, see Setting App Notifications.

## Controlling Lock Screen Notifications

To control whether notifications can be seen when the device is locked:

1. Swipe down from the Status bar to open the Quick Settings bar and then touch .
2. Touch **Apps & notifications > Notifications**.
3. Touch **On the lock screen** and select one of the following:
  - **Show all notification content** (default)
  - **Don't show notifications at all**.

## Quick Access Panel

Use the Quick Access panel to access frequently used settings (for example, Airplane mode).

**Figure 38** Quick Settings Bar

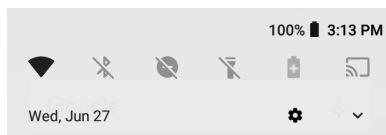

To see the full Quick Access panel:

- If the device is locked, swipe down once.
- If the device is unlocked, swipe down once with two fingers, or twice with one finger.
- If the Quick Settings bar is open, touch the Down arrow.

**Figure 39** Quick Access Panel

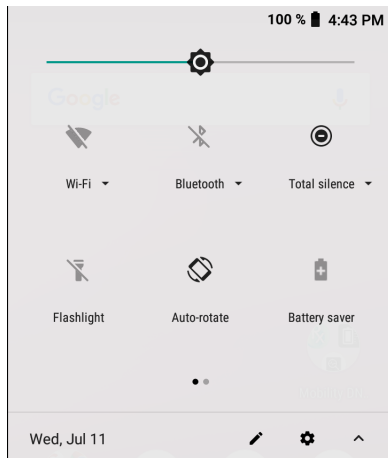

**NOTE:** Not all icons are pictured. Icons may vary.

To change a setting, touch the icon:

- Display brightness - Use the slider to decrease or increase the brightness of the screen.
- Wi-Fi network - Turn Wi-Fi on or off. To open Wi-Fi settings, touch the Wi-Fi network name.
- Bluetooth settings - Turn Bluetooth on or off. To open Bluetooth settings, touch **Bluetooth**.
- Battery saver - Turn Battery saver mode on or off. When Battery saver mode is on the performance of the device is reduced to preserve battery power.
- Invert colors - Invert the display colors.
- Do not disturb - Control how and when to receive notifications.
- Mobile data - Turns cellular radio on or off. To open Mobile data settings, touch and hold(WAN only).
- Airplane mode - Turn Airplane mode on or off. When Airplane mode is on the device does not connect to Wi-Fi or Bluetooth.
- Auto-rotate - Lock the device's orientation in portrait or landscape mode or set to automatically rotate.
- Flashlight - Turn flashlight on or off. Turn camera flash on or off.
- Location - Enable or disable locationing feature.
- Data Saver - Turn on to prevent some apps from sending or receiving data in the background.
- Night Light - Tint the screen amber to make it easier to look at the screen in dim light. Set Night Light to turn on automatically from sunset to sunrise, or at other times.
- Nearby - Helps find and interact with services and devices close to the device.
- Cast - Share phone content on Chromecast or a television with Google Cast built-in. Touch cast screen to display a list of devices, then touch a device to begin casting.

## Editing Icons on Quick Settings

The first several setting tiles from the Quick Access panel become the Quick Settings bar.

To move a setting tile:

1. Open the Quick Access panel.
2. Touch .



3. Touch and drag a setting tile to another location.
4. Release the tile.
5. Touch ← to save tiles and return to the Quick Access panel.

To add a setting tile:

1. Open the Quick Access panel.
2. Touch .
3. Slide the Quick Settings panel up to reveal additional tiles.
4. Touch and drag a setting tile from the **Drag to add tiles** area to the main area.
5. Release the tile.
6. Touch ← to save tiles and return to Quick Access panel.

To remove a setting tile:

1. Open the Quick Access panel.
2. Touch .
3. Touch and drag a setting tile to the **Drag here to remove** area.
4. Release the tile.
5. Touch ← to save tiles and return to Quick Access panel.

## App Shortcuts and Widgets

App shortcuts placed on the Home screen allow quick and easy access to apps. Widgets are self-contained apps placed on the Home screen to access frequently used features.

### Adding an App Shortcut to the Home Screen

To add an app shortcut to the Home screen:

1. Go to the desired Home screen.
2. Swipe up from the bottom of the screen.
3. Scroll through the list to find the app icon.
4. Touch and hold the icon until the Home screen appears.
5. Position the icon on the screen and then release.

### Adding a Widget to the Home Screen

To add a widget to the Home screen:

1. Go to the desired Home screen.
2. Touch and hold until the menu appears.
3. Touch **WIDGETS**.
4. Scroll through the list to find the widget.

5. Touch and hold the widget until the Home screen appears.
6. Position the widget on the screen and then release.

## Moving Items on the Home Screen

To move app shortcuts or widgets on the Home screen:

1. Touch and hold the item until it floats on the screen.
2. Drag the item to a new location. Pause at the edge of the screen to drag the item onto an adjacent Home screen.
3. Lift finger to place the item on the Home screen.

## Removing an App Shortcut or Widget from the Home Screen

To remove an app shortcut or widget from the Home screen:

1. Go to the desired Home screen.
2. Touch and hold the app shortcut or widget icon until it floats on the screen.
3. Drag the icon to **X Remove** at the top of the screen and then release.

## Folders

Use **Folders** to organize similar applications together. Tap the folder to open and display items in the folder.

### Creating a Folder

There must be at least two app icons on the Home screen.

To create a folder:

1. Go to the desired Home screen.
2. Touch and hold one app icon.
3. Drag the icon and stack on top of another icon.
4. Lift and release.

### Naming Folders

To name a folder:

1. Touch the folder.

**Figure 40** Open Folder

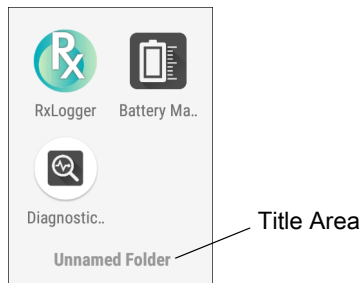

2. Touch the title area and enter a folder name using the keyboard.
3. Touch  on the keyboard.
4. Touch anywhere on the Home screen to close the folder. The folder name appears under the folder.

## Removing a Folder

To remove a folder:

1. Touch and hold the folder icon until it enlarges.
2. Drag the folder to **X Remove** and release.

## Home Screen Wallpaper

To change the Home screen wallpaper:

1. Touch and hold the screen until the menu appears.
2. Touch **WALLPAPERS**.
3. Touch **Photos** or **Gallery** to select a photo or select one of the pre-installed wallpapers.
4. Touch **Set wallpaper**.

## Using the Touchscreen

Use the multi-tap sensitive screen to operate the device.

- Tap - Tap to:
  - Select items on the screen.
  - Type letters and symbols using the on-screen keyboard.
  - Press on-screen buttons.
- Tap and Hold - Tap and hold:
  - An item on the Home screen to move it to a new location or to the trash.
  - An item in Apps to create a shortcut on the Home screen.
  - The Home screen to open a menu for customizing the Home screen.
  - An empty area on the Home screen until the menu appears.
- Drag - Tap and hold an item for a moment and then move finger on the screen until reaching the new position.

- Swipe - Move finger up and down or left and right on the screen to:
  - Unlock the screen.
  - View additional Home screens.
  - View additional app icons in the Launcher window.
  - View more information on an app's screen.
- Double-tap - Tap twice on a web page, map, or other screen to zoom in and out.
- Pinch - In some apps, zoom in and out by placing two fingers on the screen and pinching them together (to zoom out) or spreading them apart (to zoom in).

## Keyboards

Use the on-screen keyboard to enter text in a text field.

## Editing Text

Edit entered text and use menu commands to cut, copy, and paste text within or across applications. Some applications do not support editing some or all of the text they display; others may offer their own way to select text.

### Entering Numbers, Symbols, and Special Characters

To enter numbers and symbols:

- Touch and hold one of the top-row keys until a menu appears then select a number or special character.
- Touch the Shift key once for a single capital letter. Touch the Shift key twice to lock in uppercase. Touch the Shift key a third time to unlock Capslock.
- Touch **?123** to switch to the numbers and symbols keyboard.
- Touch the **=\<** key on the numbers and symbols keyboard to view additional symbols.

To enter special characters, touch and hold a number or symbol key to open a menu of additional symbols. A larger version of the key displays briefly over the keyboard.

## Keyboard Configuration



### Enabling Keyboards

To enable keyboards:

1. Swipe down from the Status bar to open the Quick Settings bar and then touch .
2. Touch **System > Languages & input > Virtual keyboard > Manage keyboards**.
3. Touch a keyboard to enable.

### Switching Between Keyboards

To switch between keyboards, touch in a text box to display the current keyboard.

- On the Android or Gboard keyboards, touch and hold .
- On the Enterprise keyboard, touch .

## Do Not Disturb Feature

This mode mutes the device so that it does not make sounds or vibrate.

For example, use Do Not Disturb to:

- Automatically limit sounds at night or during events
- Mute interruptions other than alarms
- Get alerted to messages only from favorite contacts.

## Limit Sounds and Vibrations

Mute the device completely, or let through the important alarms or important calls.

### Total Silence

To completely mute the device so that it does not make a sound or vibrate, choose **Total silence**.

In Total silence mode:

- Alarms do not make noise.
- Device does not vibrate or make sounds when receiving a message, or notification.
- Sounds from music, videos, games, and other media are muted.



**NOTE:** All alarms are silenced in Total silence mode.

1. Swipe down with two fingers from the Status bar to open the Quick Access panel.
2. Touch **Do not disturb** > **Total silence**.
3. Choose **Until you turn it off** or select a time period.
4. Touch **Done**.

When Total Silence is on,  appears in the quick access panel and the Status bar.

To turn off Total Silence, open quick access panel and touch **Total silence**.

### Alarms Only

To mute the device so that you hear alarms, choose **Alarms only**. This option does not mute sounds from music, videos, games, or other media.

1. Swipe down with two fingers from the status bar to open the quick access panel.
2. Touch **Do not disturb** > **Alarms only**.
3. Choose **Until you turn it off** or select a time period.
4. Touch **Done**.

When Alarms Only is on,  appears in the quick access panel and the Status Bar.

To turn off Alarms Only, open the Quick Access panel and touch **Alarms only**.



**NOTE:** To quickly turn on Alarms Only, with the screen on, press and hold the Volume Down button until the volume is all the way down. Then, press Volume Down again to turn on Alarms Only.

To turn off Alarms Only, press either the Volume Up or Volume Down button and the touch **END NOW** in the alert message.

## Automatically Block Sounds and Vibrations

Automatically silence the device during certain times or events, turn sounds back on, and override Do Not Disturb mode.

## Silence Sounds During Certain Times

To automatically silence the device during certain times, like at night or on weekends:



1. Swipe down from the Status bar to open the Quick Settings bar and then touch .
2. Touch **Sound > Do Not Disturb preferences**.
3. Touch a default **Weekend** or **Weeknight**. Or, to make a new rule, touch **Add more > Time rule**.
4. Enter a rule name.
5. Touch **OK**.
6. Edit the new rule:
  - **Rule name** - Rename the rule.
  - **Days, Start time, and End time** - Set the rule's schedule.
  - **Do Not Disturb preferences** - Choose whether the rule uses **Alarms only**, **Priority only**, or **Total silence**.
  - **Alarm can override end time** - Allow the alarm to continue to make sound until the next alarm begins.
7. Touch the On/Off switch at the top to turn on the rule.

## Silence Sounds During Events and Meetings

To automatically silence the device during events or meetings, set an event rules.

1. Swipe down from the Status bar to open the Quick Settings bar and then touch .
2. Touch **Sound > Do Not Disturb preferences**.
3. To edit the default rule, touch **Event**. Or, to create a new rule, touch **Add rule > Event rule**.
4. Edit the rule settings.
  - **Rule name** - Rename the rule.
  - **During events for** - Select which Google Calendar events the rule uses.
  - **Where reply is** - Set to: **Yes, Maybe, or Not replied, Yes or Maybe, or Yes**.
  - **Do Not Disturb preferences** - Choose whether the rule uses **Priority only**, **Alarms only**, or **Total silence**.
5. Touch the On/Off switch at the top to turn on the rule.

## Turn Sounds Back On

When the device is in Do Not Disturb mode, Alarms only or Priority only display as , or Total silence displays as .

To turn off Do Not Disturb, either:

- In the Quick Access panel, touch **Alarms only**, **Priority only**, or **Total silence**.
- Press the Volume Down button and touch **End Now**.

## Override Do Not Disturb for Specific Apps







To let through notifications from specific apps:

1. Swipe down from the Status bar to open the Quick Settings bar and then touch .
2. Touch **Apps & notifications > Notifications > App notifications**.
3. Touch an app.
4. Touch **Override Do Not Disturb**.













## Apps

The **APPS** screen displays icons for all installed apps. The table below lists the apps installed on the device. Refer to the device Integrator Guide for Android Version 8.1 for information on installing and uninstalling apps.

Table 7 Apps





Icon	Description
	<b>ActiveEdge Touch Zone</b> - Provides quick and convenient on-touch access to key features or applications while users are in the middle of other workflow applications or tasks.
	<b>Battery Manager</b> - Displays battery information, including charge level, status, health and wear level.
	<b>Battery Swap</b> – Use to place device in Battery Swap mode when replacing the battery.
	<b>Bluetooth Pairing Utility</b> – Use to pair the RS507 Hands-free Imager with the device by scanning a barcode.
	<b>Calculator</b> - Provides the basic and scientific arithmetic functions.
	<b>Calendar</b> - Use to manage events and appointments. GMS/GMS-Restricted only.

**Table 7** Apps (Continued)











Icon	Description
	<b>Calendar</b> - Use to manage events and appointments. AOSP only.
	<b>Camera</b> - Take photos or record videos. For more information see Camera.
	<b>Chrome</b> - Use to access the Internet or intranet. GMS/GMS-Restricted only
	<b>Chromium</b> - Use to access the Internet or intranet. AOSP only.
	<b>Clock</b> - Use to schedule alarms for appointments or as a wake-up.
	<b>Contacts</b> - Use to manage contact information. See Contacts for more information.
	<b>DataWedge</b> - Enables data capture using the imager.
	<b>Device Central</b> - Use to display detailed information about the device and connected peripherals. See Device Central for more information.
	<b>Diagnostic Tool</b> - Use to diagnose the device.
	<b>Drive</b> - Upload photos, videos, documents, and other files to personal storage site. GMS/GMS-Restricted only.
	<b>Duo</b> - A one-to-one video calling app (WWAN only). GMS/GMS-Restricted only.
	<b>DWDemo</b> - Provides a way to demonstrate the data capture features using the imager. See DataWedge Demonstration for more information.
	<b>Email</b> - Use to send and receive email. AOSP only.
	<b>Files</b> - Organize and manage files on the device. See Files for more information.



**Table 7** Apps (Continued)

Icon	Description
	<b>Gallery</b> - Use to view photos stored on the microSD card. For more information, see Gallery for more information. AOSP only.
	<b>Gmail</b> - Use to send and receive email using a Google email account. GMS/GMS-Restricted only
	<b>Google</b> - Launches Google™ search app. GMS/GMS-Restricted only
	<b>Keep</b> - Use to create, edit, and share notes. GMS/GMS-Restricted only.
	<b>License Manager</b> - Use to manage software licenses on the device.
	<b>Maps</b> - Use to see your location on a map (with public transit, traffic, or satellite overlays). Search for any business or place of interest. Provides turn-by-turn navigation with voice guidance, traffic-avoidance, and alternate routes, for drivers, cyclists, walkers, and users of public transportation. GMS/GMS-Restricted only.
	<b>Messaging</b> - Send SMS and MMS messages. See Messaging for more information. WAN devices only.
	<b>Music</b> - Play music stored on the microSD card. AOSP only.
	<b>Phone</b> - Use to dial a phone number when used with some Voice over IP (VoIP) clients (VoIP telephony ready only).
	<b>Photos</b> - Use to sync photos with Google account. For more information, see Photo Settings. GMS/GMS-Restricted only.
	<b>Play Movies &amp; TV</b> - View movies and video on your device. GMS/GMS-Restricted only.
	<b>Play Music</b> - Use to listen to music. GMS/GMS-Restricted only.
	<b>Play Store</b> - Download music, movies, books, and Android apps and games from the Google Play Store. GMS/GMS-Restricted only.
	<b>PTT Express</b> - Use to launch PTT Express client for VoIP communication.

**Table 7** Apps (Continued)

Icon	Description
	<b>RxLogger</b> - Use to diagnose device and app issues. See the device Integrator Guide for Android Version 8.1 for more information.
	<b>RxLogger Utility</b> - Use to view, backup, and archive RxLogger data.
	<b>Search</b> - Use to search the Web. Requires an Internet connection. AOSP only.
	<b>Settings</b> - Use to configure the device.
	<b>SimulScan Demo</b> - Use to demonstrate the document capture feature of the device.
	<b>Sound Recorder</b> - Use to record audio.
	<b>StageNow</b> - Allows the device to stage a device for initial use by initiating the deployment of settings, firmware, and software.
	<b>Worry Free Wifi Analyzer</b> - A diagnostic intelligent app. Use to diagnose surrounding area and display network stats, such as coverage hole detection, or AP in vicinity. Refer to the Worry Free Wi-Fi Analyzer Administrator Guide for Android.
	<b>YouTube</b> - Use to view videos on the YouTube™ web site. GMS/GMS-Restricted only.
	<b>Zebra Bluetooth</b> - Use to configure Bluetooth logging.

## Accessing Apps

All apps installed on the device are accessed using the **APPS** window.

1. On the Home screen, swipe up from the bottom of the screen.

**Figure 41** APPS Window Example

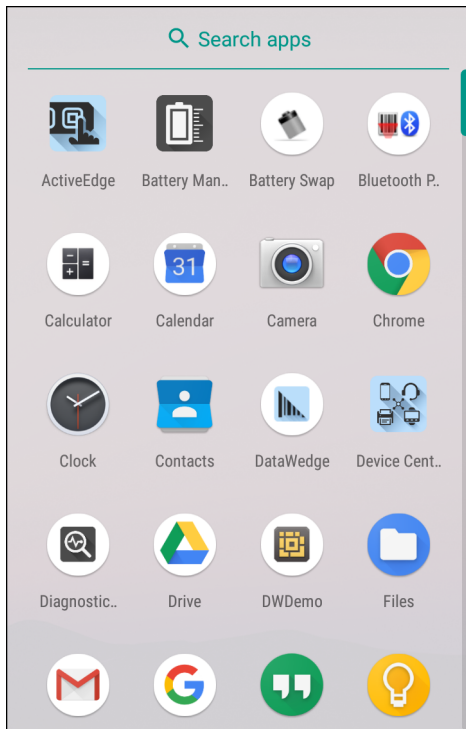

Slide the **APPS** window up or down to view more app icons. Touch an icon to open the app.

## Switching Between Recent Apps

To switch between recent apps:

1. Touch . A window appears on the screen with icons of recently used apps.

**Figure 42** Recently Used Apps

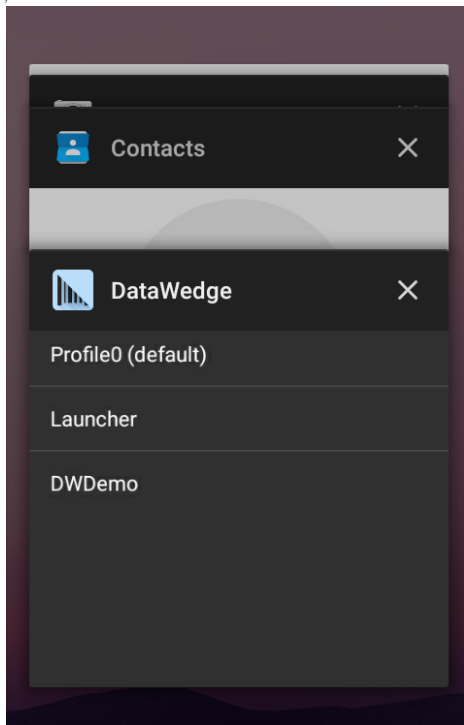

2. Slide the apps displayed up and down to view all recently used apps.
3. Swipe left or right to remove app from the list and force close the app.
4. Touch an icon to open an app or touch ◀ to return to the current screen.

## Un-Locking the Screen

Use the Lock screen to protect access to data on the device. Some email accounts require locking the screen. Refer to the device Integrator Guide for information on setting up the locking feature.

When locked, a pattern, PIN, or password is required to unlock the device. Press the Power button to lock the screen. The device also locks after a pre-defined time-out.

Press and release the Power button to wake the device. The Lock screen displays. Swipe the screen up to unlock. If the Pattern screen unlock feature is enabled, the Pattern screen appears instead of the Lock screen. If the PIN or Password screen unlock feature is enabled, enter the PIN or password after unlocking the screen.

**Figure 43** Lock Screen

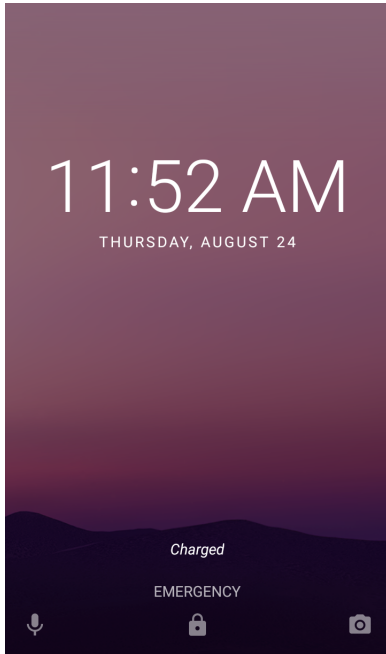

**Figure 44** PIN Screen

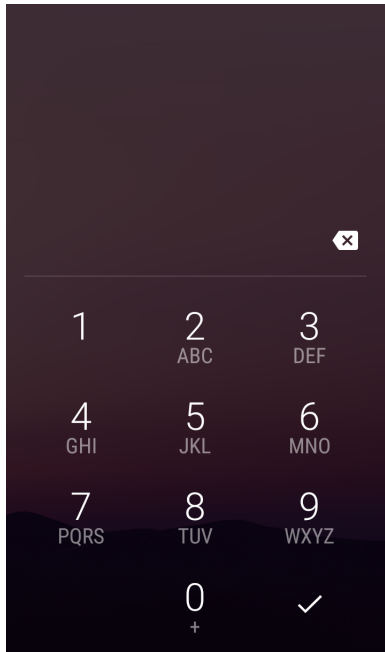

**Figure 45** Pattern Screen

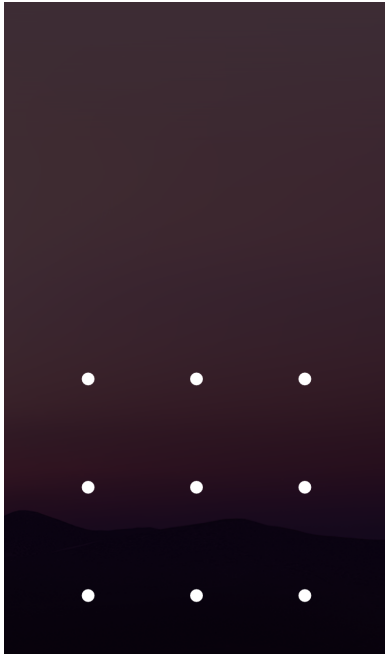

**Figure 46** Password Screen

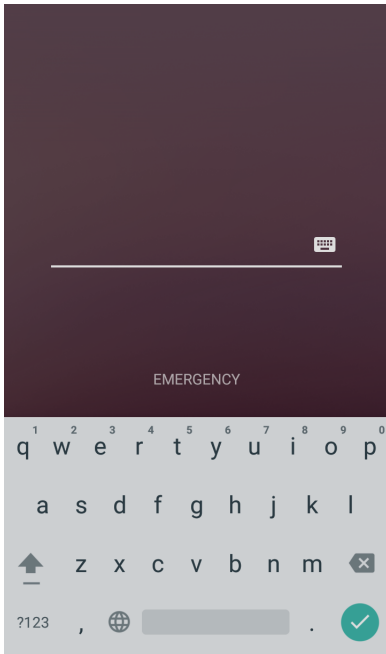

## Smart Lock

Keep the device unlocked in some situations, like when the device is in your pocket or near a specific location. With Smart Lock, the user will not need to unlock the device with a PIN, pattern, or password.

To enable Smart Lock:

1. Ensure that a screen lock feature (PIN, pattern, or password) is enabled.
2. Swipe down from the Status bar to open the Quick Settings bar and then touch .
3. Touch **Security & location > Smart Lock**.
4. Enter the PIN, pattern, or password to continue.

**Figure 47** Smart Lock Screen

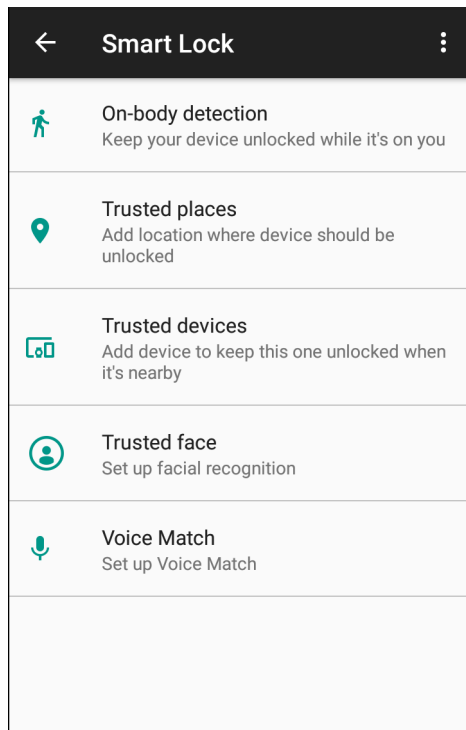

5. Select one of the options:
  - **On-body detection**
  - **Trusted places**
  - **Trusted devices**
  - **Trusted face**
  - **Voice Match.**
6. Follow the on-screen instructions for setting up each option.

## Resetting the Device

There are two reset functions, soft reset and hard reset.

### Performing a Soft Reset

Perform a soft reset if applications stop responding.

1. Press and hold the Power button until the menu appears.
2. Touch **Reset**.

3. The device reboots.

## Performing a Hard Reset



**CAUTION:** Performing a hard reset with a microSD card installed in the device may cause damage or data corruption to the microSD card. All un-saved data is lost after performing a hard reset.

Perform a hard reset if the device stops responding.

1. Simultaneously press and hold the Power button, the left scan button, and the Volume Up button for at least four seconds.
2. When the screen turns off, release the buttons.  
The device reboots.

## Suspend Mode

The device goes into suspend mode when you press the Power button or after a period of inactivity (set in the Display settings window).

To wake the device from Suspend mode, press the Power button. The Lock screen displays. Swipe the screen up to unlock. If the Pattern screen unlock feature is enabled, the Pattern screen appears instead of the Lock screen. If the PIN or Password screen unlock feature is enabled, enter the PIN or password after unlocking the screen. See Un-Locking the Screen.



**NOTE:** If you enter the PIN, password, or pattern incorrectly five times, you must wait 30 seconds before trying again. If you forget the PIN, password, or pattern contact your system administrator.

## Transferring Files with a Host Computer via USB

Connect the device to a host computer using a USB cable or a USB cradle to transfer files between the device and the host computer.

When connecting the device to a host computer, follow the host computer's instructions for connecting and disconnecting USB devices, to avoid damaging or corrupting files.

## Transferring Files



**NOTE:** Use Transfer files to copy files between the device (internal memory or microSD card) and the host computer.

1. Connect a USB cable to the device or place the device into a USB cradle.
2. Pull down the Notification panel and touch **USB charging this device**.  
By default, **Charge this device** is selected.



**Figure 48** Use USB to Dialog Box

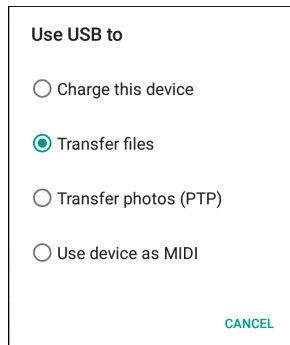

3. Touch **Transfer files**.



**NOTE:** After you change the setting to **Transfer files**, and then disconnect the USB cable, the setting reverts back to **Charge this device**. If the USB cable is reconnected, select **Transfer files** again.

4. On the host computer, open a file explorer application.
5. Locate the **device** as a portable device.
6. Open the **SD card** or the **Internal storage** folder.
7. Copy files to and from the device or delete files as required.

## Transferring Photos

To transfer photos using Photo Transfer Protocol:



**NOTE:** Use Photo Transfer Protocol (PTP) to copy photos from either the microSD card or internal memory to the host computer.

1. Connect USB cable to the device or place the device into a USB cradle. See [Accessories](#) for setup information.
2. Pull down the Notification panel and touch **USB charging this device**.
3. Touch **Transfer photos (PTP)**.
4. On the host computer, open a file explorer application.
5. Open the **SD card** or the **Internal storage** folder.
6. Copy or delete photos as required.

## Disconnect from the Host Computer

To disconnect the device from the host computer:



**CAUTION:** Carefully follow the host computer's instructions to unmount the microSD card and disconnect USB devices correctly to avoid losing information.

1. On the host computer, unmount the device.
2. Remove the USB from the device or remove the device from the cradle.



# Calls

## Introduction

Make a phone call from the **Phone** app, the **Contacts** app, or other apps or widgets that display contact information. This section applies to WWAN devices only.

## Emergency Calling

The service provider programs one or more emergency phone numbers, such as 911 or 999, that the user can call under any circumstances, even when the phone is locked, a SIM card is not inserted or the phone is not activated. The service provider can program additional emergency numbers into the SIM card. However, the SIM card must be inserted in the device in order to use the numbers stored on it. See the service provider for additional information.



**NOTE:** Emergency numbers vary by country. The phone's pre-programmed emergency number(s) may not work in all locations, and sometimes an emergency call cannot be placed due to network, environmental, or interference issues.

## Audio Modes

The device offers three audio modes for use during phone calls:

- Handset Mode - Switch audio to the receiver at the top front of the device to use the device as a handset. This is the default mode.
- Speaker Mode - Use the device as a speakerphone.
- Headset Mode - Connect a Bluetooth or wired headset to automatically switch audio to the headset.

## Using a Bluetooth Headset

Use a Bluetooth headset for audio communication when using an audio-enabled app. See [Bluetooth on page 142](#) for information on connecting a Bluetooth headset to the device. Set the volume appropriately before putting on the headset. When a Bluetooth headset is connected, the speakerphone is muted.

## Using a Wired Headset

Use a wired headset and audio adapter for audio communication when using an audio-enabled app. Set the volume appropriately before putting on the headset. When a wired headset is connected, the speakerphone is muted.

To end a call using the wired headset, press and hold the headset button until the call ends.

**Figure 49** 3.5 mm Headset Adapter

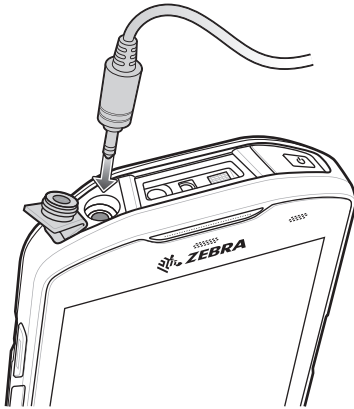



## Adjusting Audio Volume

Use the volume buttons to adjust the phone volume in the following ways:

- Ring and notification volumes when not in a call
- Conversation volume during a call.

## Making a Call Using the Dialer

Use the dialer tab to dial phone numbers.

1. On the Home screen touch .
2. Touch .



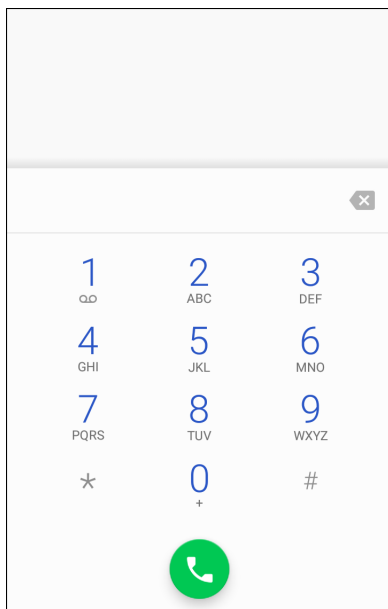



**Figure 50** Dialer Screen



3. Touch the keys to enter the phone number.
4. Touch  below the dialer to initiate the call.

**Figure 51** Call in Progress





-  - Send audio to the speakerphone.
  -  - Mute the call.
  -  - Display the dial pad.
  -  - Place the call on hold (not available on all services).
  -  - Create a conference call.
  -  - Increase audio level.
5. Touch  to end the call.

If using a Bluetooth headset, additional audio options are available. Touch the audio icon to open the audio menu.

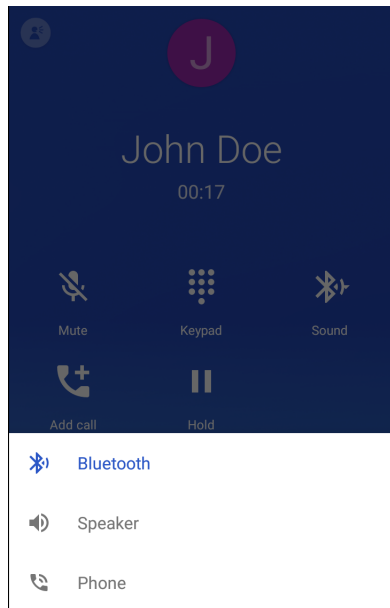
**Figure 52** Bluetooth Audio Options



-  - Audio is routed to the Bluetooth headset.
-  - Audio is routed to the speakerphone.
-  - Audio is routed to the earpiece.

## Dialer Dialing Options

The dialer provides options to save the dialed number to contacts, send an SMS, or insert pauses and wait into the dial string.

Enter at least one digit to access these options. Touch  to access the following.

- **Add 2–sec pause** - Pause the dialing of the next number for two seconds. Multiple pauses are added sequentially.
- **Add wait** - Wait for confirmation to send the rest of the digits.

## Making a Call Using Contacts

There are two ways to make a call using contacts:

- Using the Dialer
- Using the Contacts app.



### Using the Dialer

1. On the Home screen touch .

2. Touch the  tab.

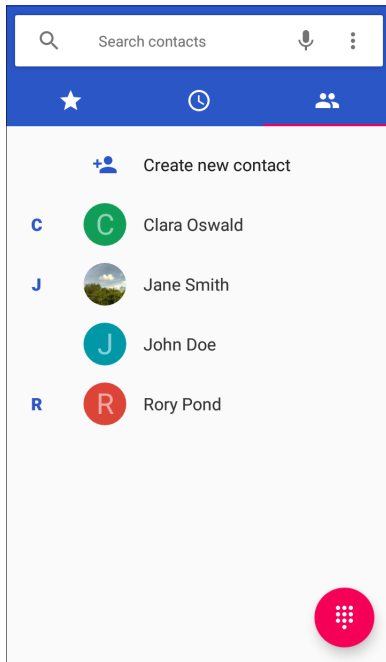
**Figure 53** Dialer Contacts Tab



3. Touch the contact.
4. Touch  to initiate the call.
5. Touch  to end the call.

## Using the Contacts App

To make a call from the Contacts app:

1. Touch .

**Figure 54** Contact app

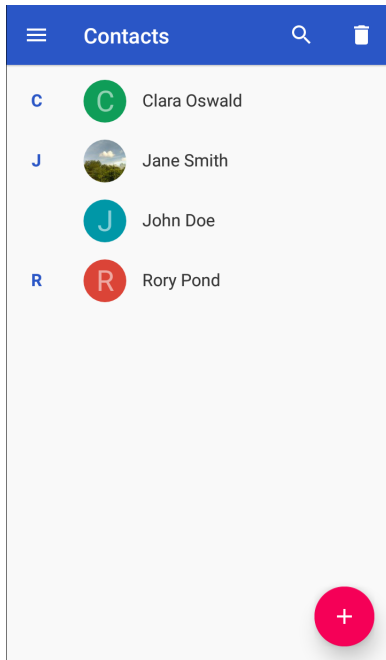

2. Touch a contact name.

**Figure 55** Contact Information

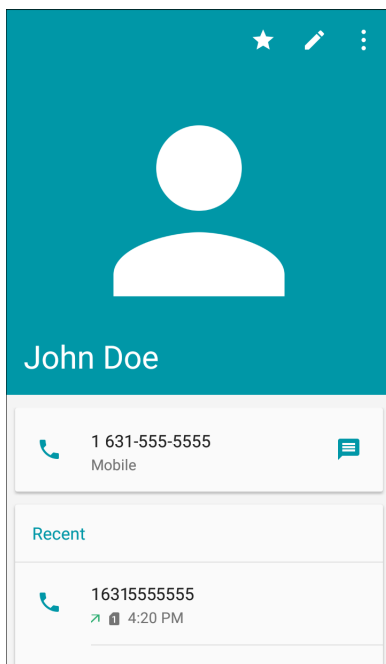

3. Touch to initiate a call.









## Making a Conference Call on GSM

To create a conference phone session with multiple people.



**NOTE:** Conference Calling and the number of conference calls allowed may not be available on all services. Please check with the service provider for Conference Calling availability.

1. On the Home screen touch .
2. Touch .
3. Touch the keys to enter the phone number.
4. Touch  below the dialer to initiate the call.
5. When the call connects, touch .  
The first call is placed on hold.
6. Touch .
7. Touch the keys to enter the second phone number.
8. Touch  below the dialer to initiate the call.
9. When the call connects, the first call is placed on hold and the second call is active.

**Figure 56** Two Calls

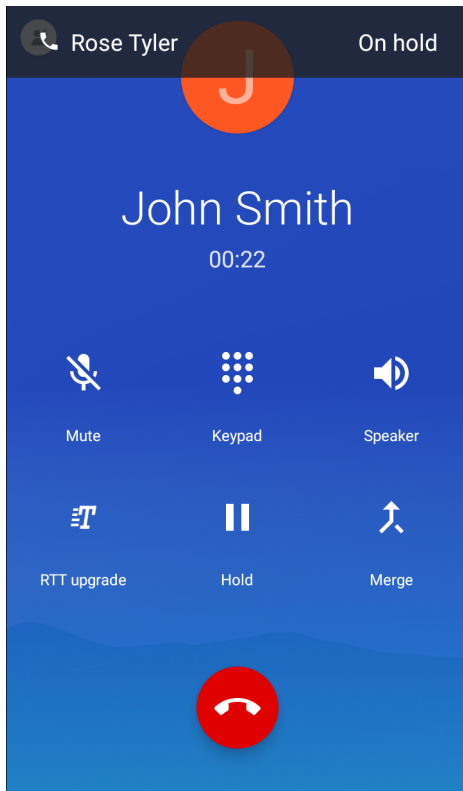

10. Touch  icon to create a conference call with three people.

**Figure 57** Merged Calls

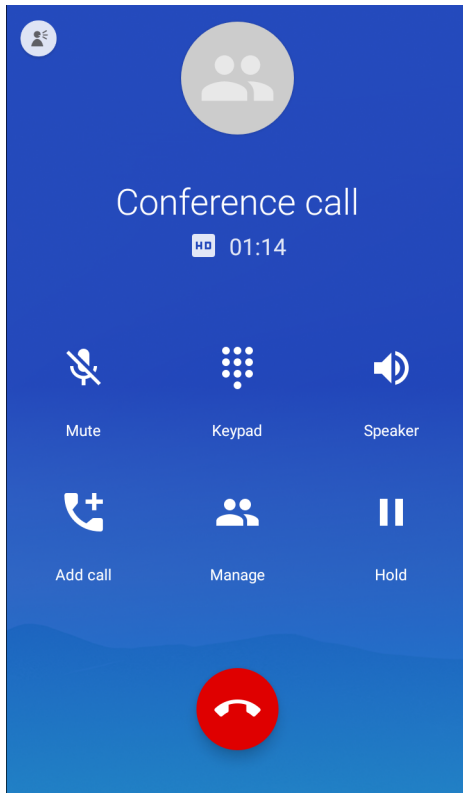



11. Touch  to add another call.

The conference is placed on hold.

12. Touch .

13. Touch the keys to enter another phone number.

14. Touch  below the dialer to initiate the call.



15. Touch  icon to add the third call to the conference.

16. Touch **Manage** to view all callers.

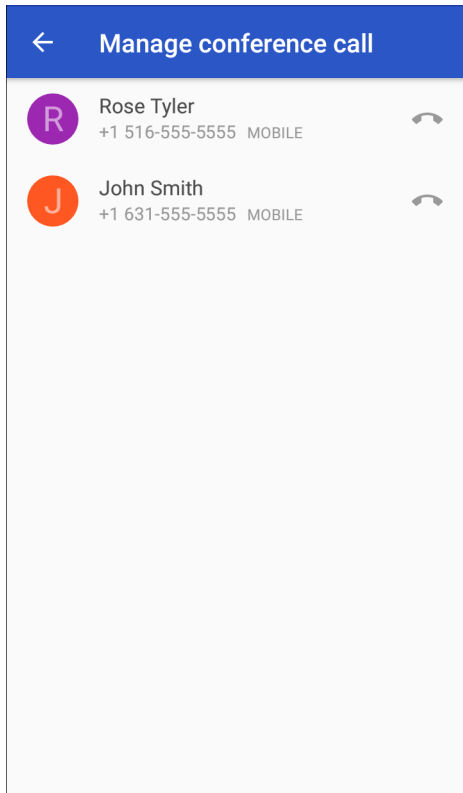
**Figure 58** Un-merge Calls



17. To remove a caller from the conference, touch  next to the caller.

To speak privately with one party during a conference call, touch . To include all parties again, touch .

## Making a Call Using a Bluetooth Headset

To make a call using a Bluetooth headset:

1. Pair the Bluetooth headset with the device.
2. Press the Call button on the Bluetooth headset.
3. Press the Call button on the Bluetooth headset to end the call.

## Answering Calls

When receiving a phone call, the **Incoming Call** screen displays the caller ID and any additional information about the caller that is in the **Contacts** app.

**Figure 59** Incoming Call Screen

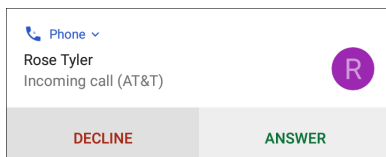



Touch **ANSWER** to answer the call or **DECLINE** to send the caller to voice mail.

If the screen lock is enabled, the user can answer the call without unlocking the device.

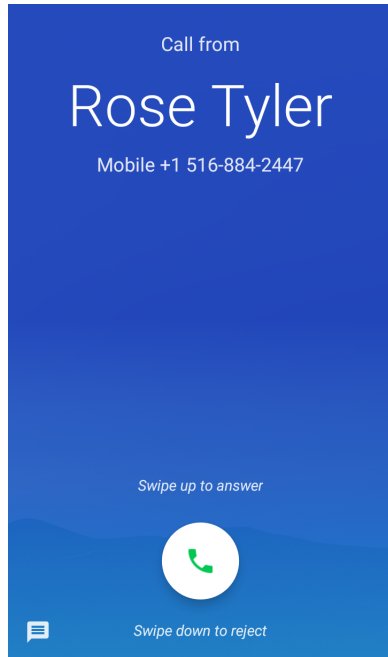
**Figure 60** Incoming Call Locked Screen



When a call arrives:

- Touch  and slide up to answer the call.
- Touch  and slide down to send the call to voice mail.
- Touch  to open a list of quick text responses. Touch one to send it to the caller immediately.

When the calls ends, the device remains locked.

If using a Bluetooth headset when a call arrives, touch the Call button on the Bluetooth headset to answer the call. To end the call press the headset Call button.

All incoming calls are recorded in the Phone app Call log tab. If you miss a call, you receive a notification. To silence the ringer before answering the call, press the volume down button on the side of device.

## Call Settings



**NOTE:** Not all options are available for all configurations

To modify phone call settings, on the Home screen touch  >  > **Settings**.

- **Display options**
  - **Sort by** - Set to **First name** or **Last name**.
  - **Name format** - Set to **First name first** or **Last name first**.

- **Sounds and vibrations**
  - **Phone ringtone** - Select a ringtone to sound when an incoming call is received.
  - **Also vibrate for calls** - Check to make the device vibrate when a call is received (default - disabled).
  - **keypad tones** - Check to play a sound when a phone key is touched (default - enabled).
  - **keypad tone length** - Set the tone length to **Normal** (default) or **Long**.
- **Quick responses** - Touch to edit quick responses to use instead of answering a call.
- **Speed dial settings** - Set speed dial contact shortcuts.
- **Calls**
  - **Calling accounts**
    - **SIP accounts** - Choose to receive Internet calls for accounts added to the device, view or change SIP accounts, or add an Internet calling account.
    - **Use SIP calling** - Set to **For all calls** or **Only for SIP calls** (default).
    - **Receive incoming calls** - Enable to allow incoming calls (default - disabled).
  - **Call forwarding** - Set to forward incoming calls to a different phone number.



**NOTE:** Call Forwarding may not be available on all networks. Check with the service provider for availability.

- **Additional settings**
  - **Caller ID** - Set caller ID to reveal the identity of the person making an outgoing call. Options: **Network default** (default), **Hide number**, **Show number**.
  - **Call waiting** - Set to be notified of an incoming call while on a call.
- **Call blocking** - Set to block calls and texts from certain phone numbers. Touch **ADD A NUMBER** to block a phone number.
- **Voicemail** - Configure voicemail settings.
  - **Notifications**
    - **Importance** - Set the notification importance to **Urgent**, **High** (default), **Medium**, or **Low**.
    - **Sound** - Select a sound to play when a voicemail is received.
    - **Vibrate** - Set vibrate to **On** (default) or **Off**.
    - **Advanced** - Use toggle switches to enable or disable **Blink link**, **Show notification**, or **Override Do Not Disturb**. Available options vary depending on the Importance setting.
  - **Advanced Settings**
    - **Service** - Set the service provider or other provider for voicemail service.
    - **Setup** - Select to update the phone number used to access voicemail.
- **Accessibility**
  - **TTY mode** - Touch to set the TTY setting. Use an optional teletypewriter (TTY) with the device to send and receive calls. Plug the TTY into the device headset jack and set the device to operate in one of the TTY modes.



**NOTE:** Use a TSB-121 compliant cable (provided by the TTY manufacturer) to connect the TTY to the device.

Set the device volume to a middle level setting for proper operation. If you experience a high number of incorrect characters, adjust the volume as needed to minimize the error rate.

For optimal performance, the device should be at least 30 cm (12 inches) from the TTY. Placing the device too close to the TTY may cause high error rates.

- **TTY off** - TTY is off (default)
- **TTY Full** - Transmit and receive TTY characters

- **TTY HCO** - Transmit TTY characters, but receive by listening to earpiece
- **TTY VCO** - Receive TTY characters, but transmit by speaking into microphone.
- **Hearing aids** - Select to enable hearing air compatibility.
- **RTT settings** - Configure Real-time text (RTT) settings.
  - **Real-time text (RTT) call** - Select to allow messaging during a call.
  - **Set RTT visibility** - Set to **Visible during calls** (default) or **Always visible**.

# Applications

## Introduction

This section describes the applications installed on the device.

## ActiveEdge Touch Zone

The **ActiveEdge Touch Zone** app provides configurable settings which enable quick and convenient one-touch access to key features or apps while using other apps.



**NOTE:** The **ActiveEdge Touch Zone** is only available when the display is set to Portrait mode.

## Configuring ActiveEdge

**Figure 61** ActiveEdge App Settings

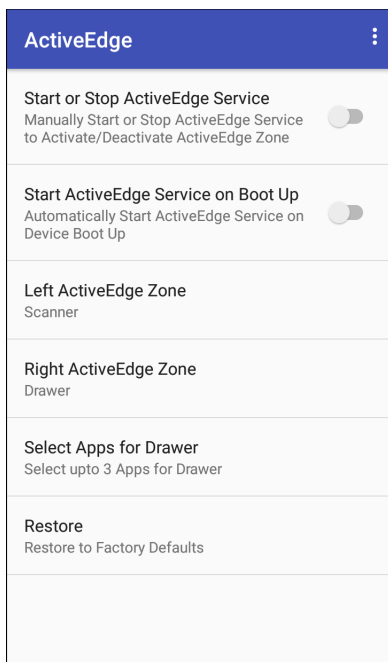

To configure ActiveEdge, swipe up from the bottom of the Home screen and touch .

- **Start or Stop ActiveEdge Service** - Touch to start/stop the ActiveEdge service to enable/disable the ActiveEdge Zone.
- **Start ActiveEdge Service on Boot Up** - Automatically start the ActiveEdge service when the device boots up. The service is always running and available.
- **Left ActiveEdge Zone** - Configure the left ActiveEdge Zone to **Scanner**, **Drawer**, or **None**.
- **Right ActiveEdge Zone** - Configure the right ActiveEdge Zone to **Scanner**, **Drawer**, or **None**.

**Figure 62** Left and Right ActiveEdge Zones

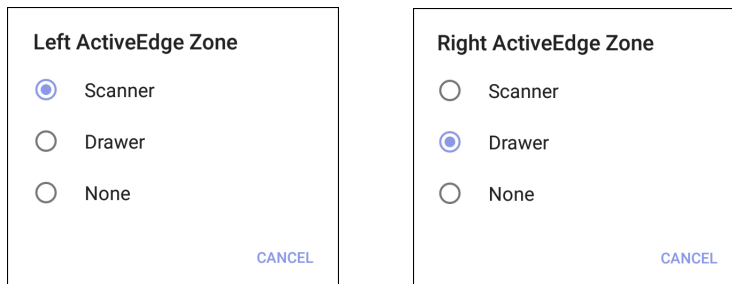

- **Select Apps for Drawer** - Select up to three apps to appear in the drawer. See [Selecting Apps for a Drawer on page 81](#).
- **Restore** - Restore the settings to the factory defaults.
- **About ActiveEdge** - Open the **About ActiveEdge** window to display the version number. Select **⋮** > **About**.

## Selecting Apps for a Drawer

When the **Left ActiveEdge Zone** or the **Right ActiveEdge Zone** is set to **Drawer**, select up to three apps to display in the drawer.

To select which apps display in the drawer:



1. Touch **Select Apps for Drawer**.

Figure 63 Select Apps for Drawer

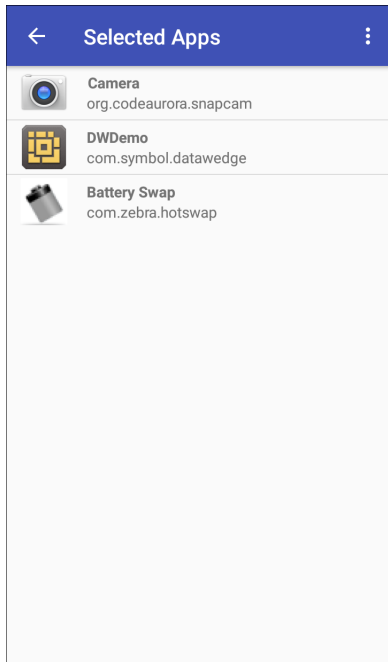

2. Touch **☰ > Select Apps**.

Figure 64 Select Apps for Drawer

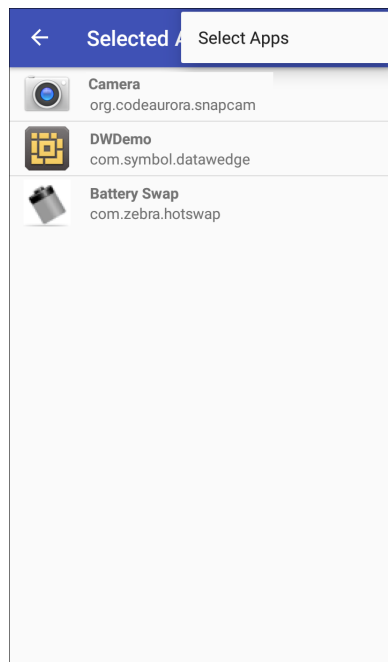

3. Choose up to three apps to appear in the **Drawer**.



**NOTE:** Configure the **Left ActiveEdge Zone** and the **Right ActiveEdge Zone** to any combination of **Scanner**,

**Drawer**, or **None**, except that both zones cannot be set to **Drawer**.

Figure 65 Select Apps for Drawer

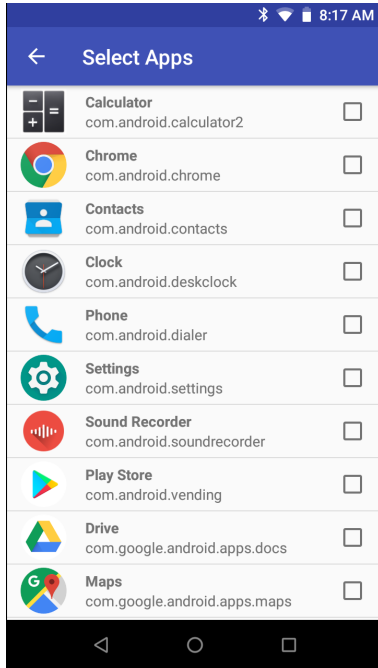

4. Touch .

## Battery Manager

The **Battery Manager** provides detailed information about the battery.

To open Battery Manager, swipe up from the bottom of the Home screen and touch .

Figure 66 Battery Manager Screen

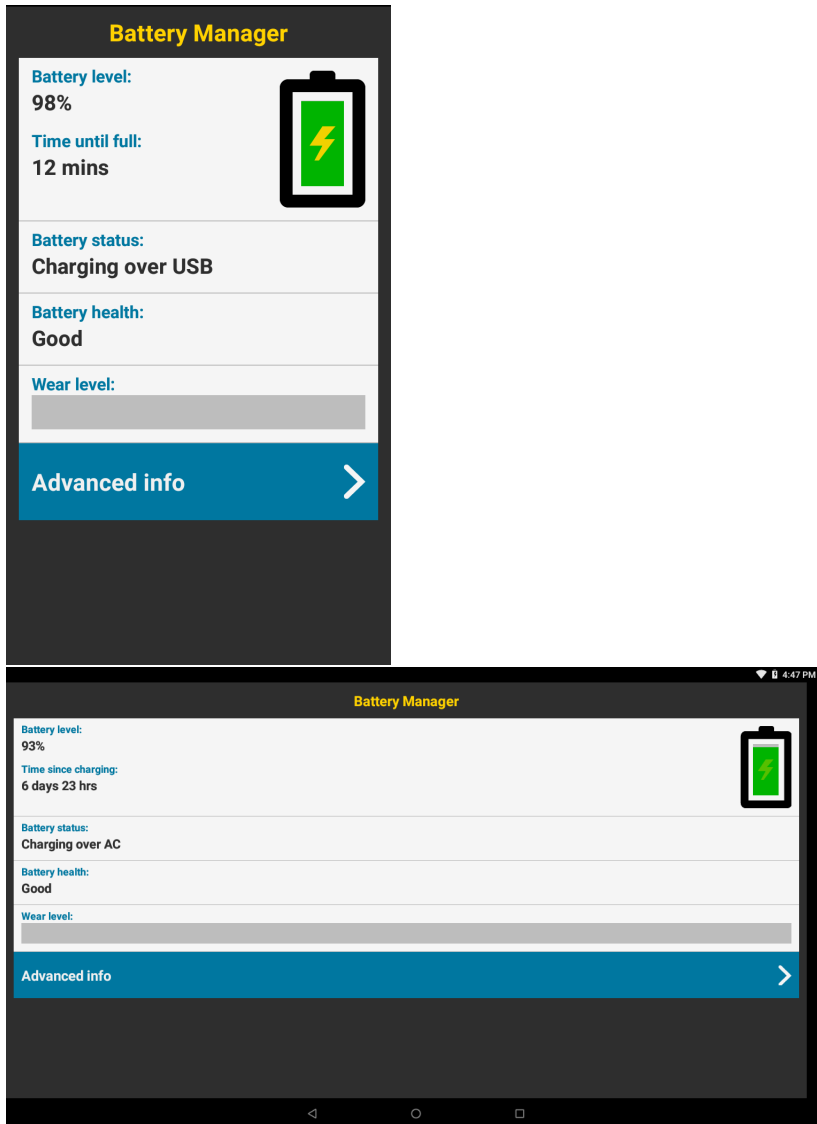





Table 8 Battery Icon Description

Battery Icon	Description
	Battery charge level.
	Battery charging.
	Battery charge level is below 20%.

- **Battery level** - The current battery charge level as a percentage. Displays -% when level is unknown.
- **Time until full** - The amount of time until the battery is fully charged.
- **Time since charging** - The amount of time since the device began charging.
- **Time until empty** - The amount of time until the battery is empty.
- **Battery status**
  - **Not charging** - The device is not connected to AC power.
  - **Charging over AC** - The device is connected to AC power and charging.
  - **Charging over USB** - The device is connected to a host computer with a USB cable and charging.
  - **Discharging** - That the battery is discharging.
  - **Full** - That the battery is fully charged.
  - **Unknown** - The battery status is unknown.
- **Battery health** - The health of the battery. If a critical error occurs,  appears. Touch to view the error description.
  - **Decommission** - The battery is past its useful life and should be replaced. See system administrator.
  - **Good** - The battery is good.
  - **Charge error** - An error occurred while charging. See system administrator.
  - **Over Current** - An over-current condition occurred. See system administrator.
  - **Dead** - The battery has no charge. Replace the battery.
  - **Over Voltage** - An over-voltage condition occurred. See system administrator.
  - **Below Temperature** - The battery temperature is below the operating temperature. See system administrator.
  - **Failure Detected** - A failure has been detected in the battery. See system administrator.
  - **Unknown** - See system administrator.
- **Wear level** - The health of the battery in graphical form. When the wear level exceeds 80%, the bar color changes to red.
- **Advanced info** - Touch to view additional battery information.
  - **Battery present status** - Indicates that the battery is present.
  - **Battery level** - The battery charge level as a percentage of scale.
  - **Battery scale** - The battery scale level used to determine battery level (100).
  - **Battery voltage** - The current battery voltage in millivolts.
  - **Battery temperature** - The current battery temperature in degrees Centigrade.
  - **Battery technology** - The type of battery.
  - **Battery current** - The average current into or out of the battery over the last second in mAh.
  - **Battery manufacture date** - The date of manufacture.
  - **Battery serial number** - The battery serial number. The number matches the serial number printed on the battery label.
  - **Battery part number** - The battery part number.
  - **Battery rated capacity** - Lists the rated capacity of the backup battery in mAh.
  - **Battery decommission status** - Indicates if the battery is past its life span.
    - **Battery Good** - The battery is in good health.

- **Decommissioned Battery** - The battery is past its useful life and should be replaced.
- **Base cumulative charge** - Cumulative charge using Zebra charging equipment only.
- **Battery present capacity** - Maximum amount of charge that could be pulled from the battery under the present discharge conditions if the battery were fully charged.
- **Battery health percentage** - With a range from **0** to **100**, this is the ratio of “present\_capacity” to “design\_capacity” at a discharge rate of “design\_capacity”.
- **% decommission threshold** - The default % decommission threshold for a gifted battery as 80%.
- **Battery present charge** - Amount of usable charge remaining in the battery at present under the current discharge conditions.
- **Battery total cumulative charge** - The total accumulated charge in all chargers.
- **Battery time since first use** - The time passed since the battery was placed in a Zebra terminal for the first time.
- **Battery error status** - The error status of the battery.
- **App version** - The application version number.

## Camera

This section provides information for taking photos and recording videos using the integrated digital cameras.



The device saves photos and videos on the microSD card, if installed and the storage path is changed manually. By default, or if a microSD card is not installed, the device saves photos and videos on the internal storage.

### Taking Photos





**NOTE:** See Photo Settings for camera setting descriptions.

1. Swipe up from the bottom of the Home screen and touch **Camera**.

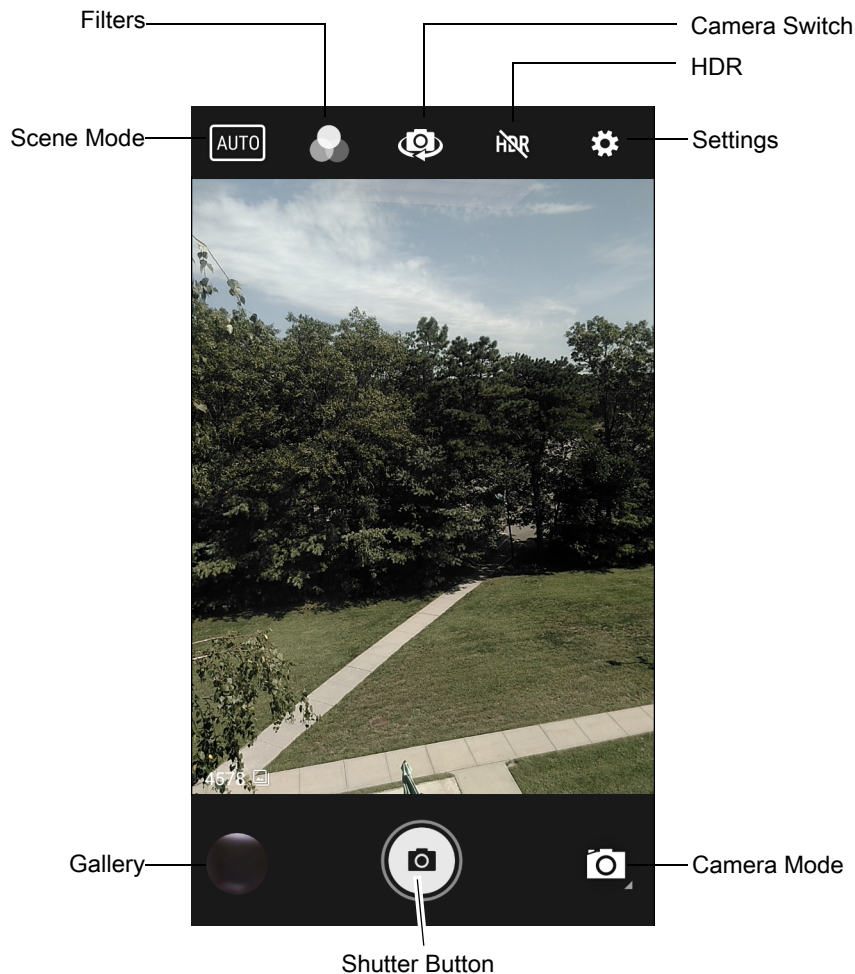
**Figure 67** Camera Mode



2. If necessary, touch the Camera Mode icon and touch .
3. To switch between the rear camera and front camera, touch .
4. Frame the subject on the screen.

5. To zoom in or out, press two fingers on the display and pinch or expand fingers. The zoom controls appear on the screen.
6. Touch an area on the screen to focus. The focus circle appears. The two bars turn green when in focus.
7. Touch .
  - The camera takes a photo and a shutter sound plays.
  - The photo momentarily displays as a thumbnail in the lower left corner.



## Taking a Panoramic Photo

Panorama mode creates a single wide image by panning slowly across a scene.

1. Swipe up from the bottom of the Home screen and touch **Camera**.

**Figure 68** Panoramic Mode







2. Touch the Camera Mode icon and touch .
3. Frame one side of the scene to capture.
4. Touch  and slowly pan across the area to capture. A small white square appears inside the button indicating the capture is in progress.
  - If you are panning too quickly, the message **Too fast** appears.
5. Touch  to end the shot. The panorama appears immediately and a progress indicator displays while it saves the image.

## Recording Videos

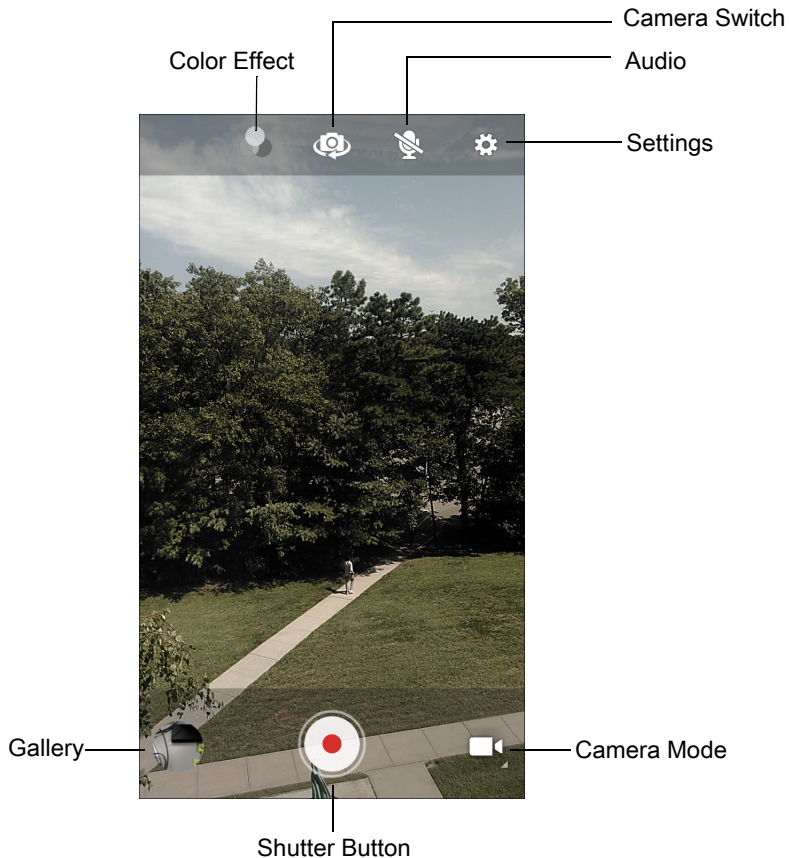
1. Swipe up from the bottom of the Home screen and touch **Camera**.
2. Touch the camera mode menu and touch .

**Figure 69** Video Mode







3. To switch between the rear camera and front camera (if available), touch .
4. Point the camera and frame the scene.
5. To zoom in or out, press two fingers on the display and pinch or expand fingers. The zoom controls appear on the screen.
6. Touch  to start recording.  
The video time remaining appears in the top left of the screen.
7. Touch  to the end recording.  
The video momentarily displays as a thumbnail in the lower left corner.







## Photo Settings





In Photo mode, photo settings appear on screen. Touch  to display the photo settings options.

### Front Camera

- **Selfie Flash** - Turns screen white to help produce a little extra light in dimmer settings. Options: **Off** (default), or **On**.
- **GPS location** - Add GPS location information to the photo meta-data. Options: **On** or **Off** (default).
- **Picture size** - Set the size (in pixels) of the photo to: **5M pixels** (default), **3M pixels**, **HD1080**, **2M pixels**, **HD720**, **1M pixels**, **WVGA**, **VGA**, or **QVGA**.
- **Picture quality** - Set picture quality setting to: **Low**, **Standard** (default) or **High**.
- **Countdown timer** - Set to: **Off** (default), **2 seconds**, **5 seconds** or **10 seconds**.
- **Storage** - Set location to store the photo to: **Phone** or **SD Card**.
- **Face Detection** - Select to turn face detection **Off** (default) or **On**.
- **ISO** - Set how sensitive the camera is to light. Options: **Auto** (default), **ISO Auto (HJR)**, **ISO100**, **ISO200**, **ISO400**, **ISO800** or **ISO1600**.
- **Exposure** - Touch to adjust the exposure settings. Options: **+2**, **+1**, **0** (default), **-1** or **-2**.
- **White balance** - Select how the camera adjusts colors in different kinds of light, to achieve the most natural-looking colors:
  -  **Incandescent** - Adjust the white balance for incandescent lighting.
  -  **Fluorescent** - Adjust the white balance for florescent lighting.
  -  **Auto** - Adjust the white balance automatically (default).
  -  **Daylight** - Adjust the white balance for daylight.
  -  **Cloudy** - Adjust the white balance for a cloudy environment.
- **Redeye reduction** - Helps eliminate redeye effect. Options: **Disabled** (default), or **Enable**.
- **ZSL** - Set the camera to immediately take a picture when the button is pressed (default – enabled)
- **Selfie Mirror** - Options: **Disable** (default), or **Enable**.
- **Anti Banding** - Allows the camera to avoid problems caused by artificial light sources that are not constant. These sources cycle (flicker) fast enough to go unnoticed to the human eye, appearing continuous. The camera's eye (its sensor) can still see this flicker. Options: **Auto** (default), **60 Hz**, **50 Hz**, or **Off**.

### Rear Camera





- **Flash** - Select whether the camera relies on its light meter to decide whether a flash is necessary, or to turn it on or off for all shots.
  -  **Off** - Disable flash.
  -  **Auto** - Adjust flash automatically depending upon light meter (default).
  -  **On** - Enable flash upon taking a photo.
  -  **Torch** - Turn flash on continuously.
- **GPS location** - Turn On or Off (default).
- **Picture size** - The size (in pixels) of the photo to: **13M pixels** (default), **8M pixels**, **5M pixels**, **3M pixels**, **HD 1080**, **2M pixels**, **HD720**, **1M pixels**, **WVGA**, **VGA**, or **QVGA**.

- **Picture quality** - Set the picture quality setting to: **Low**, **Standard** (default) or **High**.
- **Countdown timer** - Select **Off** (default), **2 seconds**, **5 seconds** or **10 seconds**.
- **Storage** – Set the location to store the photo to: **Phone** or **SD Card**.
- **Face Detection** - Select to turn face detection **Off** (default) or **On**.
- **ISO** - Set camera sensitivity to light to: **Auto** (default), **ISO Auto (HJR)**, **ISO100**, **ISO200**, **ISO400**, **ISO800** or **ISO1600**.
- **Exposure** - Set the exposure settings to: **+2**, **+1**, **0**(default), **-1** or **-2**.
- **White balance** - Select how the camera adjusts colors in different kinds of light, to achieve the most natural-looking colors:
  -  **Incandescent** - Adjust the white balance for incandescent lighting.
  -  **Fluorescent** - Adjust the white balance for florescent lighting.
  -  **Auto** - Adjust the white balance automatically (default).
  -  **Daylight** - Adjust the white balance for daylight.
  -  **Cloudy** - Adjust the white balance for a cloudy environment.
- **Chroma Flash** - Sets the camera to take two pictures, one with flash and one without flash. The two images are combined to produce a final image with the sharpness and clarity and bright color tones from a picture with the flash, coupled with the natural colors of a picture without a flash. Options: **Off** (default) or **On**.
- **Redeye reduction** - Helps eliminate redeye effect. Options: **Disabled** (default), or **Enable**.
- **ZSL** - Set the camera to immediately take a picture when the button is pressed (default – enabled).
- **Anti Banding** - Allows the camera to avoid problems caused by artificial light sources that are not constant. These sources cycle (flicker) fast enough to go unnoticed to the human eye, appearing continuous. The camera's eye (its sensor) can still see this flicker. Options: **Auto** (default), **60 Hz**, **50 Hz**, or **Off**.







### Video Settings

In Video mode, video settings appear on screen. Touch  to display the video settings options.

### Front Camera

- **Video quality** - Set video quality to: **HD1080** (default), **HD720**, or **SD 480p**.
- **Video duration** - Set to: **30 seconds (MMS)** or **30 minutes** (default).
- **GPS location** - Turn **On** or **Off** (default).
- **Storage** – Set the location to store the photo to: **Phone** (default) or **SD Card**.**White balance** - Select how the camera adjusts colors in different kinds of light, to achieve the most natural-looking colors.
  -  **Incandescent** - Adjust the white balance for incandescent lighting.
  -  **Fluorescent** - Adjust the white balance for florescent lighting.
  -  **Auto** - Adjust the white balance automatically (default).
  -  **Daylight** - Adjust the white balance for daylight.
  -  **Cloudy** - Adjust the white balance for a cloudy environment.
- **Image Stabilization** - Set to reduce blurry videos due to device movement. Options: **On** or **Off** (default).

## Rear Camera

- **Flash** - Select whether Rear-facing Camera relies on its light meter to decide whether a flash is necessary, or to turn it on or off for all shots.
  -  **Off** - Disable flash (default).
  -  **Torch** - Turn flash on continuously.
- **Video quality** - Set video quality to: **HD 1080p** (default), **HD 720p**, **SD 480p**.
- **Video duration** - Set to: **30 seconds (MMS)**, or **30 minutes** (default).
- **GPS location** - Turn On or Off (default).
- **Storage** – Set the location to store the photo to: **Phone** (default) or **SD Card**.
- **White balance** - Select how the camera adjusts colors in different kinds of light, to achieve the most natural-looking colors.
  -  **Incandescent** - Adjust the white balance for incandescent lighting.
  -  **Fluorescent** - Adjust the white balance for florescent lighting.
  -  **Auto** - Adjust the white balance automatically (default).
  -  **Daylight** - Adjust the white balance for daylight.
  -  **Cloudy** - Adjust the white balance for a cloudy environment.
- **Image Stabilization** - Set to reduce blurry videos due to device movement. Options: **On** or **Off** (default).

## Contacts

Use the **Contacts** app to manage contacts.

From a Home or Apps screen, touch **Contacts** to open to the main list of contacts. Contacts are listed in alphabetical order. Swipe up or down to scroll through the list.

## Adding a Contact

1. In the **Contacts** app, touch .
2. If there is more than one account with contacts, touch the one you want to use.
3. Type the contact's name and other information. Touch a field to start typing, and swipe down to view all categories.
4. To open a menu with preset labels, such as Home or Work for an email address, touch the label to the right of the item of contact information. Or, to create your own label, touch **Custom** in the menu.
5. Touch the check mark next to **Add New Contact**.

## Editing Contacts

1. In the **Contacts** app, touch a contact name to edit.
2. Touch .
3. Edit the contact information.

4. Touch **SAVE**.

### Deleting Contacts

1. In the **Contacts** app, touch a contact name to delete.
2. Touch .
3. Touch **Delete**.
4. Touch **DELETE** to confirm.

## Device Central

**Device Central** displays detailed information about the device and connected peripherals and supports the following Zebra devices:

- RS507/RS507X Hands-free Imager
- RS6000 Bluetooth Ring Scanner
- RS5000 Corded Ring Scanner
- HS3100 Bluetooth Headset
- DS3678 Digital Scanner.

Device Central features include:

- Discovering and pairing with supported peripherals via Bluetooth or corded connection.
- Paging a connected RS6000 Ring Scanner.
- Updating the firmware of supported ring scanners. Refer to the RS5000 Quick Start Guide or RS6000 User Guide for more information.
- Displaying the connection status of peripherals.
- Displaying information for a connected peripheral in the notification bar.

**Figure 70** Device Central Screen

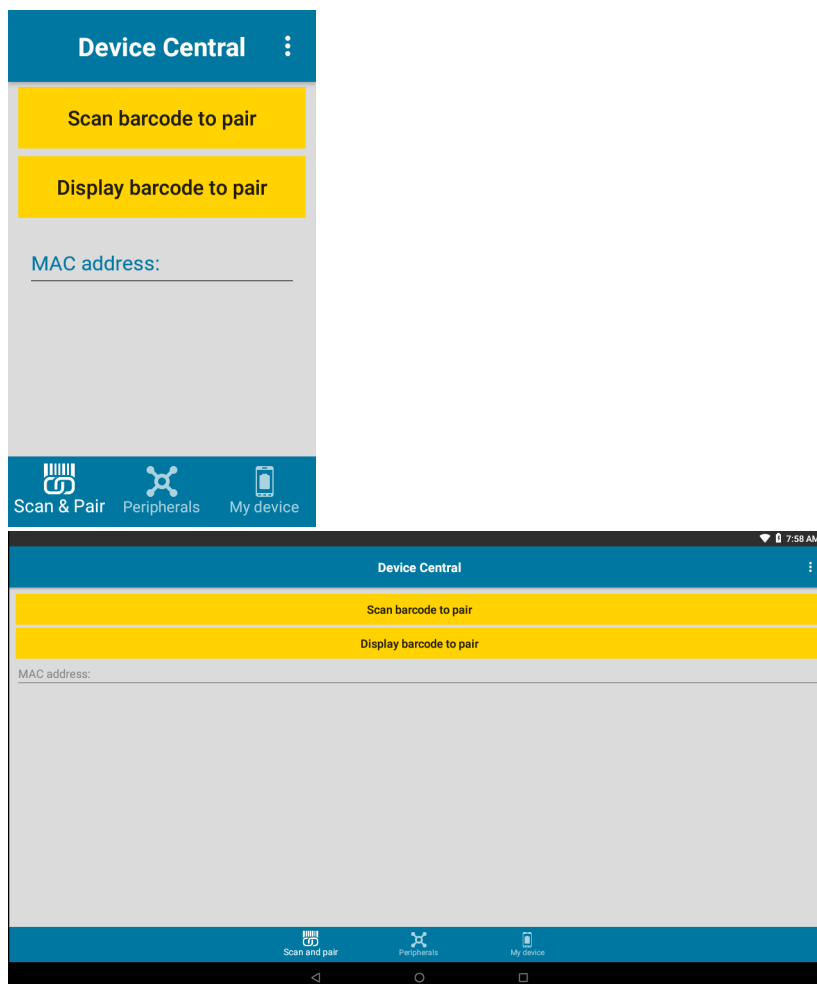

## Device Central Tabs

- **Peripherals** Tab - displays all currently connected and previously connected peripherals. Connected peripherals display the length of time (in minutes) that they have been connected. When an RS6000 is connected the **Page** button displays. See Paging an RS6000 Ring Scanner.

Touch the peripheral information to display the **Device Details** screen.

- **Device Details** - displays detailed device information for the selected peripheral.
- **My Device** Tab - displays information about the device and the current version of Device Central.
  - **Device Details** - displays the **Phone status** screen.
  - **Device Battery Details** - displays the **Battery** screen.

**Figure 71** Peripherals Tab

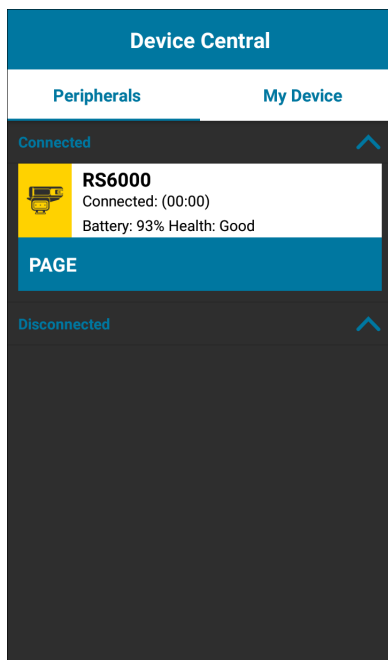

## Paging an RS6000 Ring Scanner

Use **Page** button to easily locate the currently connected RS6000 Ring Scanner:

1. With the RS6000 Ring Scanner connected, swipe up from the bottom of the Home screen, and touch .



**NOTE:** The RS6000 Ring Scanner must be within 10 m (32 ft) of the device.

2. Under the RS6000 peripheral information, touch **Page** to page the RS6000. The paged RS6000 beeps and vibrates.

**Figure 72** Page RS6000

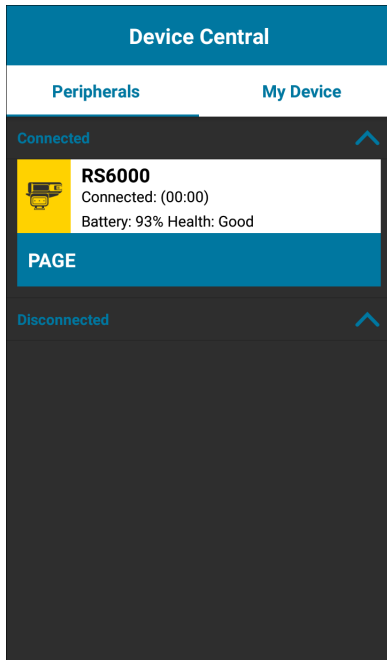

To stop paging, press the scan trigger of the RS6000. On a triggerless RS6000, reset the RS6000 to stop paging. Refer to the RS6000 User Guide.

## DataWedge Demonstration



**NOTE:** DataWedge is disabled enabled on the Home screen. To enable disable this feature, go to the DataWedge settings and enable Barcode input option disable the **Launcher** profile.

Use **DataWedge Demonstration** to demonstrate data capture functionality.

**Figure 73** DataWedge Demonstration Window

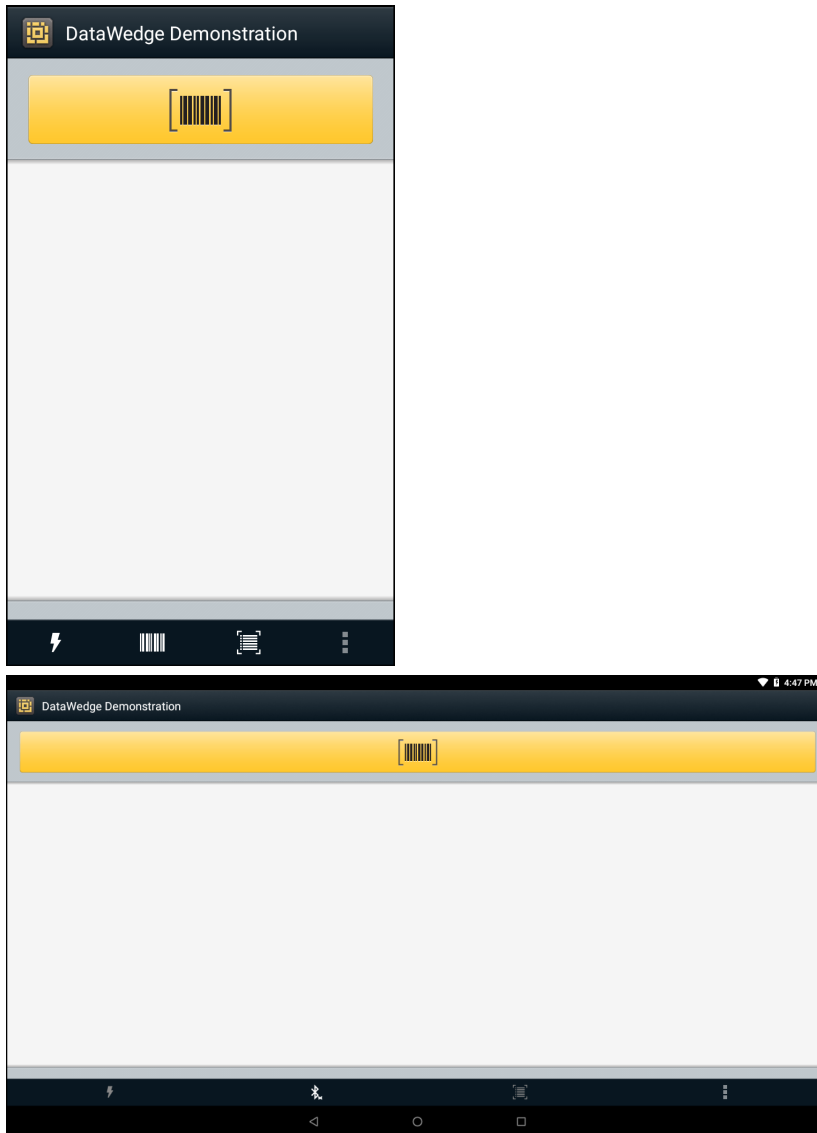









**Table 9** DataWedge Demonstration Icons

	Icon	Description
Illumination		Imager illumination is on. Touch to turn illumination off.
		Imager illumination is off. Touch to turn illumination on.



**Table 9** *DataWedge Demonstration Icons (Continued)*

	Icon	Description
Data Capture		The data capture function is through the internal imager.
Data Capture		Indicates a USB scanner is connected to the device.
		Indicates a USB scanner is not connected to the device.
		An RS507 or RS6000 Bluetooth imagerBluetooth scanner is connected.
		An RS507 or RS6000 Bluetooth imagerBluetooth scanner is not connected.
		The data capture function is through the rear camera.
Scan Mode		Imager is in picklist mode. Touch to change to normal scan mode.
		Imager is in normal scan mode. Touch to change to picklist mode.
		Opens a menu to view the application information or to set the application DataWedge profile.



**NOTE:** See the device Integrator Guide for Android Version 8.1 for information on DataWedge configuration. See [DataWedge on page 150](#) for more information.

## Scanner Selection

To select a scanner, touch  > **Settings** > **Scanner selection**.

See Data Capture for more information.

Either press the programmable button or touch the yellow scan button to capture data. The data appears in the text field below the yellow button. Press the scanner trigger button or touch the on-screen yellow scan button to capture data. The data appears in the text field below the yellow button.

## Diagnostic Tool

The **Diagnostic Tool** is a utility that determines the health of the device. Use the Diagnostic Tool to troubleshoot the device.

1. Swipe up from the bottom of the Home screen and touch .

**Figure 74** Diagnostic Tool

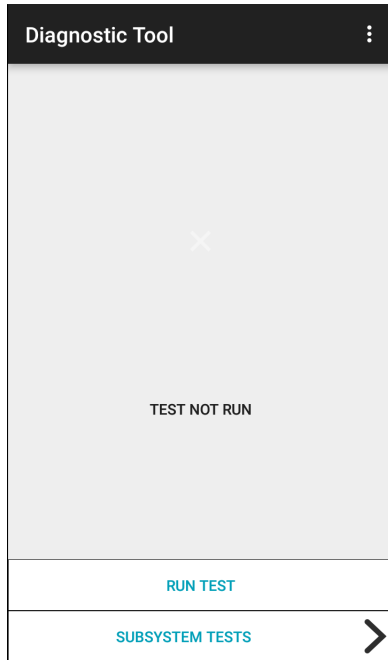

2. Touch **RUN TEST**. The app tests all enabled subsystems (by default, only the Battery and System tests). See Settings to enable subsystem tests.

**Figure 75** Test Passed Screen

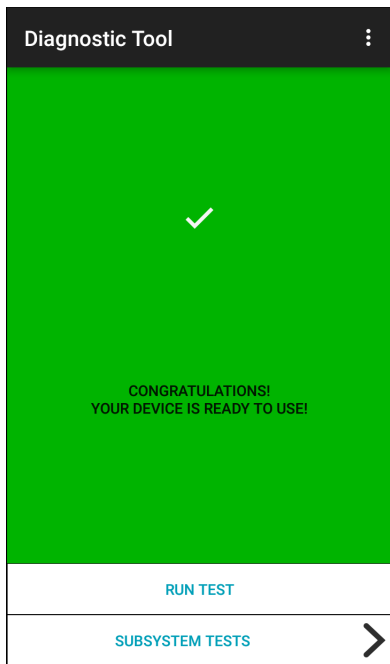

**Figure 76** Test Failed Screen

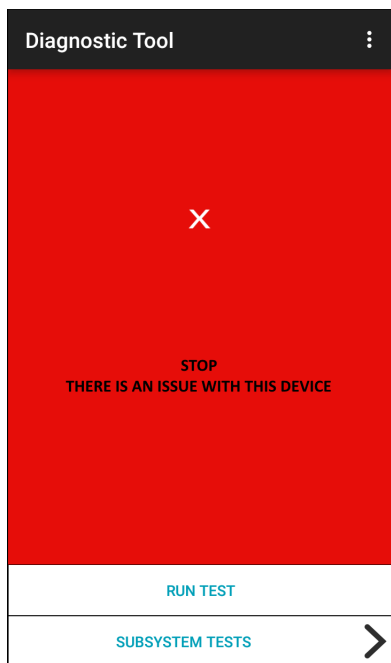

3. To view each subsystem test, touch **Subsystem Tests**.

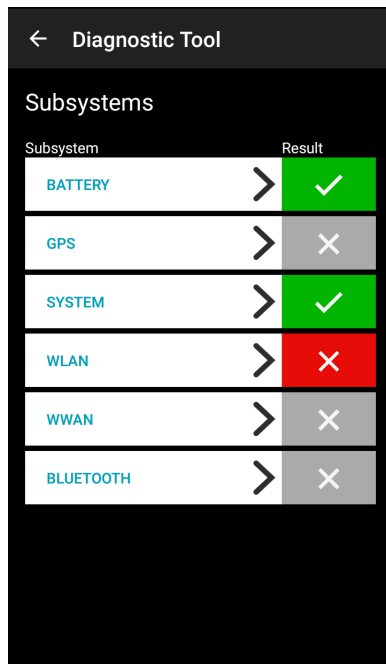
**Figure 77** Subsystem Screen

4. Touch one of the subsystems to view details.

**Table 10** *Subsystem Test Result Indicators*



Status Icon	Description
	Test passed.
	Test failed.
	Test not supported or not enabled.

Figure 78 Battery Subsystem Details



## Settings

By default only the Battery and System tests are enabled. To enable other tests:

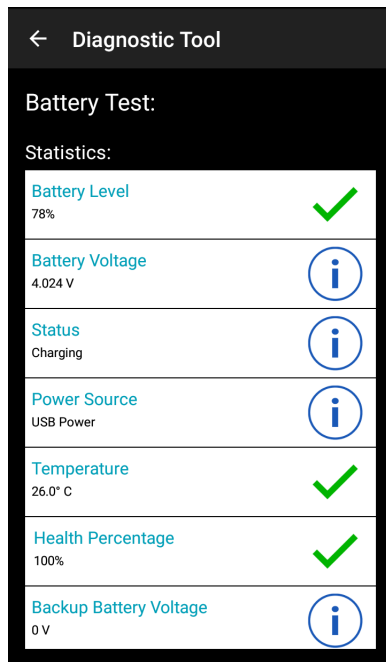
1. Touch **☰** > **Settings**.
2. Touch to the left of the test name. A green box with a checkmark appears.
3. Touch **SAVE**.
4. Touch **Yes** to confirm.
5. Touch **◀**.

## Battery Test Information

The Battery Test obtains the following information:

- **Battery Level** - Current battery charge level
- **Battery Voltage** - Current battery voltage
- **Status** - Whether the battery is charging (on AC power) or discharging (on battery power)
- **Power Source** - Whether the device is receiving power from the battery or from an external source
- **Temperature** - Current battery temperature
- **Health Percentage** - Indicates the ratio of present capacity to design capacity at a discharge rate of design capacity.
- **Backup Battery Voltage** - Backup battery voltage.
- **Manufacture Date** - Manufacture date of the battery.

## GPS Test Information

The GPS Test obtains the following information (WWAN only):

- **GPS Provider Enabled** - Whether GPS is enabled (true) or disabled (false)
- **Latitude** - Current latitude position
- **Longitude** - Current longitude position
- **Altitude** - Current altitude in meters
- **Bearing** - Current bearing
- **Speed** - Speed in meters per second
- **Accuracy** - GPS accuracy in meters.

## System Test Information

Use the System Test to determine if the CPU or memory loads are too high, there are too many processes running on the device, or storage on the device is almost full.

The System Test obtains the following information:

- **CPU Load** - Amount of CPU being used
- **Free Physical Memory** - Amount of RAM available
- **Free Storage** - Amount of internal Flash memory available
- **Process Count** - Number of processes currently running.

## WLAN Test Information

If the WiFi radio is not present or disabled, skip this test. This test determines if the device's WLAN configuration is correct or whether there is any connection with an access point or network.

The WLAN test obtains the following information:

- **WLAN Enabled** - WLAN radio is enabled or disabled
- **WLAN Status** - Current status of association with the access point
- **ESSID** - Name of the wireless network
- **BSSID** - MAC address of the connected access point
- **MAC Address** - Device's MAC address
- **Signal** - Strength of the Wi-Fi signal (in dBm)
- **IP Address** - IP address of the device.

## WWAN Test Information

The WWAN Test obtains the following information (WWAN only):

- **SIM State** - Current state of the SIM card
- **WAN Type** - Data connection type
- **Signal Strength** - Current cellular signal strength
- **Phone Number** - Phone number assigned to the device

- **Device ID** - Device ID number.

### Bluetooth Test Information

The Bluetooth Test obtains the following information:

- **Enabled** - Whether the Bluetooth radio is enabled or disabled
- **Status** - Whether the device is paired to another Bluetooth device
- **Connectable/Discoverable** - Whether the device is discoverable or able to connect
- **Address** - Bluetooth radio MAC address
- **Name** - Bluetooth name for the device.



## Files

Use the **Files** app to view and manage files on the device.



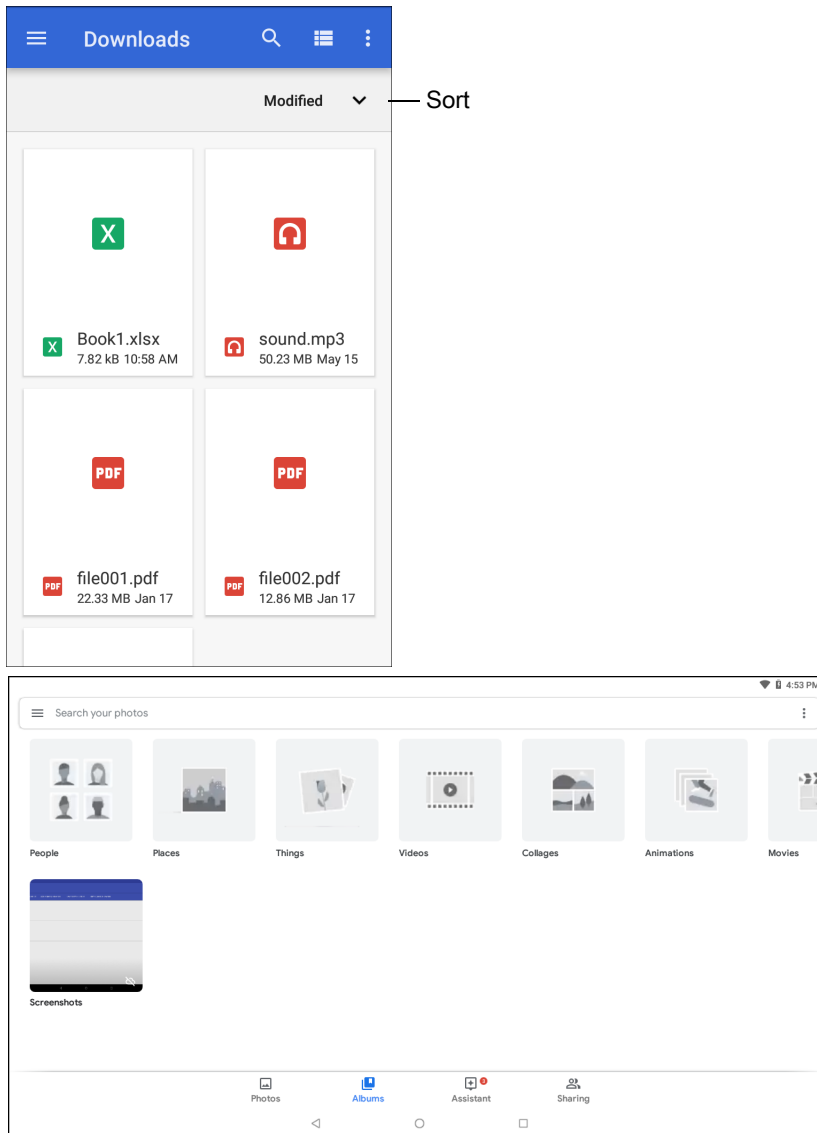

To open **Files**, swipe up from the bottom of the screen and touch .

**Figure 79** Files Screen



- Touch and hold an item to open the File Operations menu. Select an option:
  -  - Share the file with other devices.
  -  - Delete the file.
  -  - View additional options.
    - **Open with** - Select which app is used to open the file.
    - **Select all** - Select all folders and files.
    - **Copy to...** - Copy the file.
    - **Move to...** - Move the file or folder to a new location.



- **Compress** - Compress the selected file(s) into a ZIP file.
- **Rename** - Rename the file.
- Touch the Sort drop-down to sort files by name, type, size, or date.
-  - View all file locations.
-  - Search for a specific file on the device.
-  /  - Change the folder to display items as a list / grid.
-  - Open the options menu.
  - **New Window** - Create a new Files window.
  - **New Folder** - Create a new folder.
  - **Select all** - Select all folders and files.
  - **Show/Hide internal storage** - Show or hide internal storage.

## Gallery



**NOTE:** The device supports the following image formats: jpeg, gif, png and bmp.

The device supports the following video formats: H.263, H.264 and MPEG4 Simple Profile.

Available on device with AOSP only.

Use Gallery to:

- View photos
- Play videos
- Perform basic editing of photos
- Set photos as wallpaper
- Set photos as a contact photo
- Share photos and videos.

**Gallery** presents all photos and videos stored on the microSD card and internal memory.

To open **Gallery**, swipe up from the bottom of the Home screen and touch **Gallery**, or in the camera app touch the thumbnail image at the bottom left.

By default, **Gallery** opens to the **Timeline** view.

**Figure 80** Gallery - Timeline View



Touch  > **Albums** to view photos sorted by albums or  > **Videos** to view only videos.

**Figure 81** Gallery — Albums View

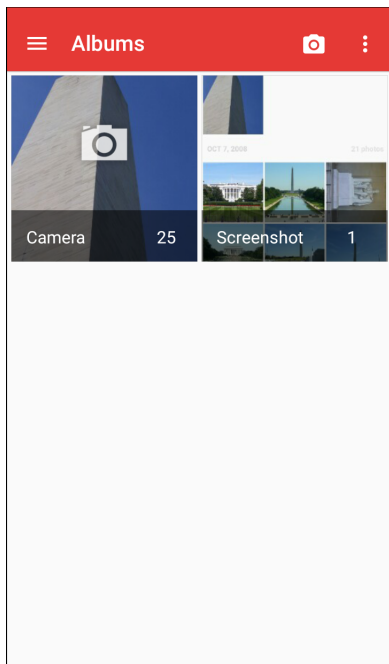

- Touch an album to open it and view its contents. The photos and videos in the album are displayed in chronological order.
- Touch a photo or video in an album to view it.
- Touch  > **Timeline** to return to the default **Gallery** screen.

## Working with Albums

Albums are groups of images and videos in folders. Touch an album to open it. The photos and videos are listed in a chronologically ordered grid. The name of the album displays at the top of the screen.

**Figure 82** Photos Inside an Album



Swipe up or down to scroll through the images.

## Sharing an Album

1. Swipe up from the bottom of the Home screen and touch **Gallery**.
2. Touch and hold an album to highlight it.
3. Touch other albums as required.
4. Touch . The Share menu opens.
5. Touch the app to use to share the selected albums.
6. Follow the instructions within the selected app.

## Getting Album Information

1. Swipe up from the bottom of the Home screen and touch **Gallery**.
2. Touch and hold an album to highlight it.
3. Touch .
4. Touch **Details**.

## Deleting an Album

To delete an album and its contents:

1. Swipe up from the bottom of the Home screen and touch **Gallery**.
2. Touch and hold an album to highlight it.
3. Check other albums to delete.
4. Touch .
5. In the **Delete selected item?** menu, touch **OK** to delete the album.

## Working with Photos

Use **Gallery** to view photos on the device and edit and share photos.

### Viewing and Browsing Photos

To view a photo:

1. Swipe up from the bottom of the Home screen and touch **Gallery**.
2. Touch an album to open it.
3. Touch a photo.

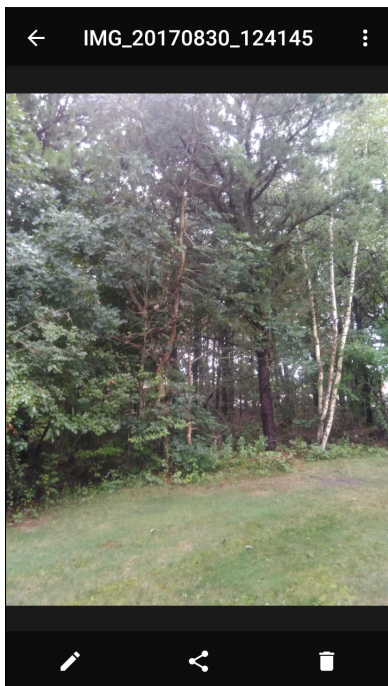

**Figure 83** Photo Example



4. Swipe left or right to view the next or previous photo in the album.
5. Turn the device to view the photo in upright (portrait) or sideways (landscape) orientation. The photo is displayed (but not saved) in the new orientation.

6. Touch the photo to view the controls.
7. Double-tap the screen to zoom in or pinch two fingers together or spread them apart to zoom in or out.
8. Drag the photo to view parts that are not in view.

## Cropping a Photo

1. In **Gallery**, touch a photo to view the controls.
2. Touch  >  > . The cropping tool appears.
3. Use the cropping tool to select the portion of the photo to crop.
  - Drag from the inside of the cropping tool to move it.
  - Drag an edge of the cropping tool to resize it to any proportion.

**Figure 84** Cropping Tool

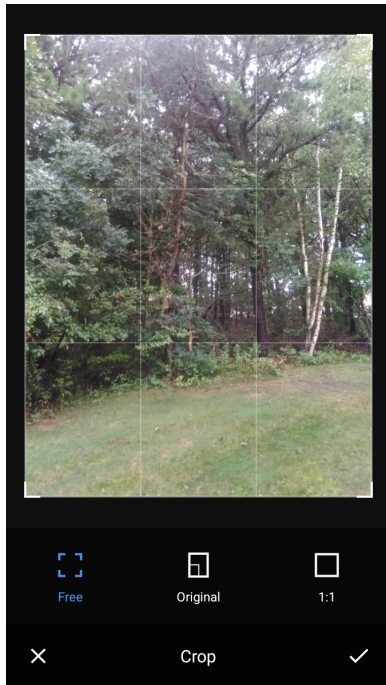

4. Touch  > **SAVE** to save a copy of the cropped photo. The original version is retained.

## Setting a Photo as a Contact Icon

1. Swipe up from the bottom of the Home screen and touch **Gallery**.
2. Touch an album to open it.
3. Touch a photo to open it.
4. Touch .
5. Touch **Set picture as**.
6. Touch **Contact photo**.
7. In **Contacts**, touch a contact.

8. Touch the white box and crop the photo accordingly.
9. Touch **SAVE**.

### Sharing a Photo

1. Swipe up from the bottom of the Home screen and touch **Gallery**.
2. Touch an album to open it.
3. Touch a photo to open it.
4. Touch .
5. Touch the app to use to share the selected photo.
6. Follow the instructions within the selected app.

### Deleting a Photo

1. Swipe up from the bottom of the Home screen and touch **Gallery**.
2. Touch an album to open it.
3. Touch a photo to open it.
4. Touch .
5. Touch **OK** to delete the photo.

## Working with Videos

Use **Gallery** to view and share videos.

### Watching Videos

1. Swipe up from the bottom of the Home screen and touch **Gallery**.
2. Touch an album to open it.
3. Touch a video.
4. Touch  to play.
5. Touch the screen to view the playback controls.

### Sharing a Video

1. Swipe up from the bottom of the Home screen and touch **Gallery**.
2. Touch an album to open it.
3. Touch a video to open it.
4. Touch . The Share menu appears.
5. Touch the app to use to share the selected video.
6. Follow the instructions within the selected app.

### Deleting a Video

1. Swipe up from the bottom of the Home screen and touch **Gallery**.
2. Touch an album to open it.
3. Touch a video to open it.
4. Touch .
5. Touch **OK**.



## Photos



**NOTE:** The device supports the following image formats: jpeg, gif, png, and bmp.

The device supports the following video formats: H.263, H.264, and MPEG4 Simple Profile.

Available on device with GMS only.

Use **Photos** to:

- View photos
- Play videos
- Perform basic editing of photos
- Set photos as wallpaper
- Set photos as a contact photo
- Share photos and videos.

**Photos** presents all photos and videos stored on the microSD card and internal memory.

To open **Photos**, swipe up from the bottom of the Home screen and touch **Photos**.

By default, **Photos** opens to the photos view.

**Figure 85** Photos View

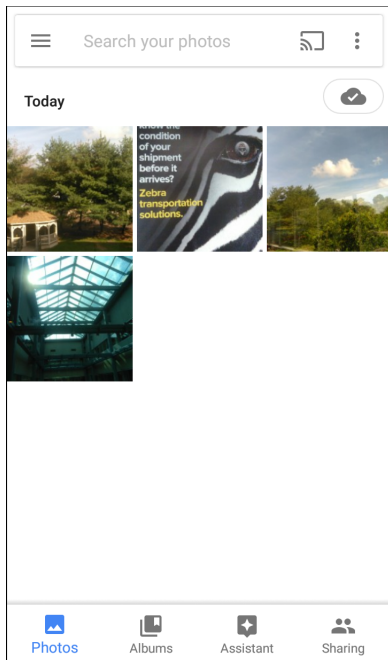

Touch **Albums** to view photos sorted by albums.

**Figure 86** Albums View

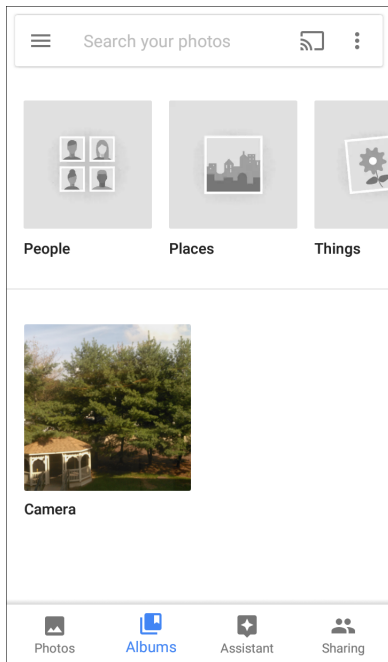

- Touch an album to view its contents. The photos and videos in the album appear in chronological order.
- Touch a photo or video in an album to view it.
- Touch ← to return to the main screen.

## Working with Albums

Albums are groups of images and videos in folders. Touch an album to open it. The photos and videos are listed in a chronologically ordered grid. The name of the album displays at the top of the screen.

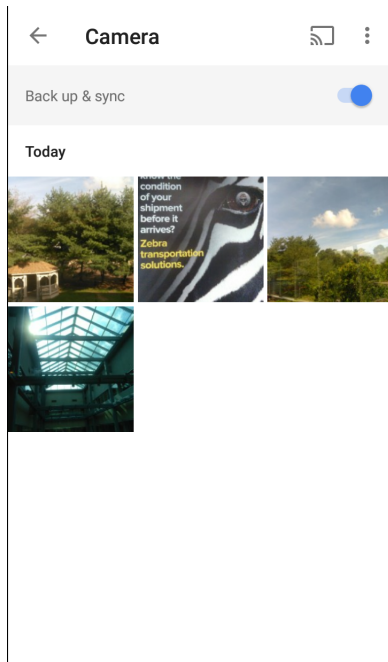
**Figure 87** Photos Inside an Album

Swipe up to scroll through the images.

## Sharing an Album

1. Swipe up from the bottom of the Home screen and touch **Photos**.
2. Touch **Albums**.
3. Touch an album.
4. Touch **⋮** > **Select**.
5. Select all photos in the album.
6. Touch **🔗**. The Share menu opens.
7. Touch an app to share the selected albums.
8. Follow the instructions within the selected app.

## Deleting an Album

To delete an album and its contents:

1. Swipe up from the bottom of the Home screen and touch **Photos**.
2. Touch **Albums**.
3. Touch an album.
4. Touch **⋮** > **Select**.
5. Select all photos in the album.
6. Touch **🗑️**.

7. Touch **Move to trash** to delete the album.

## Working with Photos

Use **Photos** to view photos on the internal memory and the microSD card.

### Viewing and Browsing Photos

1. Swipe up from the bottom of the Home screen and touch **Photos**.
2. Touch a photo.



**Figure 88** Photo Example



3. Swipe left or right to view the next or previous photo in the album.
4. Turn the device to view the photo in upright (portrait) or sideways (landscape) orientation. The photo is displayed (but not saved) in the new orientation.
5. Touch the photo to view the controls.
6. Double-tap the screen to zoom in, or pinch two fingers together or spread them apart to zoom in or out.
7. Drag the photo to view parts that are not in view.

### Cropping a Photo

1. Swipe up from the bottom of the Home screen and touch **Photos**.
2. Touch a photo to view the controls.

3. Touch  > . The cropping tool appears.

**Figure 89** Cropping Tool



4. Use the cropping tool to select the portion of the photo to crop.
  - Drag from the inside of the cropping area to move it.
  - Drag an edge of the cropping area to resize it to any proportion.
5. Touch **DONE**.
6. Touch **SAVE** to save a copy of the cropped photo. The original version is retained.

### Setting a Photo as a Contact Icon

1. Swipe up from the bottom of the Home screen and touch **Photos**.
2. Touch the photo to open it.
3. Touch  > **Use as**.
4. Touch **Contact photo**.
5. In the **Contacts** app, touch a contact.
6. Touch the white box and crop the photo accordingly.
7. Touch **Done**.

### Sharing a Photo

1. Swipe up from the bottom of the Home screen and touch **Photos**.

2. Touch an album to open it.
3. Touch a photo to open it.
4. Touch .
5. Touch the app to use to share the selected photo.
6. Follow the instructions within the selected app.

### Deleting a Photo

1. Swipe up from the bottom of the Home screen and touch **Photos**.
2. Touch a photo to open it.
3. Touch .
4. Touch **MOVE TO TRASH**.

### Working with Videos

Use **Photos** to view and share videos.

#### Watching a Video

1. Swipe up from the bottom of the Home screen and touch **Photos**.
2. Touch a video to play.
3. Touch the screen to view the playback controls.

#### Sharing a Video

1. Swipe up from the bottom of the Home screen and touch **Photos**.
2. Touch a video to open it.
3. Touch . The Share menu appears.
4. Touch the app to use to share the selected video.
5. Follow the instructions within the selected app.

#### Deleting a Video

1. Swipe up from the bottom of the Home screen and touch **Photos**.
2. Touch a video to open it.
3. Touch .
4. Touch **MOVE TO TRASH** to delete the video.

## PTT Express Voice Client



**NOTE:** PTT Express Voice Client enables Push-To-Talk (PTT) communication between disparate enterprise devices. Leveraging existing Wireless Local Area Network (WLAN) infrastructure, PTT Express delivers simple PTT communication without requiring a voice communication server.

- **Group Call:** Press and hold the PTT (Talk) button to start communicating with other voice client users.
- **Private Response:** Double-press the PTT button to respond to the originator of the last broadcast or to make a Private Response.

### PTT Audible Indicators

The following tones provide helpful cues when using the voice client.

- **Talk Tone:** Double chirp. Plays when the Talk button is depressed. This is a prompt for you to start talking.
- **Access Tone:** Single beep. Plays when another user just finished a broadcast or response. You can now initiate a Group Broadcast or Private Response.
- **Busy Tone:** Continuous tone. Plays when the Talk button is depressed and another user is already communicating on the same talkgroup. Plays after the maximum allowed talk time is reached (60 seconds).
- **Network Tone:**
  - Three increasing pitch beeps. Plays when PTT Express acquires the WLAN connection and the service is enabled.
  - Three decreasing pitch beeps. Plays when PTT Express loses the WLAN connection or the service is disabled.



### PTT Notification Icons

Notification icons indicate the current state of the PTT Express Voice client.

**Table 11** PTT Express Icon Descriptions

Status Icon	Description
	The PTT Express Voice client is disabled.
	The PTT Express Voice client is enabled but not connected to a WLAN.
	The PTT Express Voice client is enabled, connected to a WLAN, and listening on the Talk Group indicated by the number next to the icon.
	The PTT Express Voice client is enabled, connected to a WLAN, and communicating on the Talk Group indicated by the number next to the icon.
	The PTT Express Voice client is enabled, connected to a WLAN, and in a private response.

**Table 11** *PTT Express Icon Descriptions (Continued)*

Status Icon	Description
	The PTT Express Voice client is enabled and muted.
	The PTT Express Voice client is enabled but it is not able to communicate due to a VoIP telephony call in progress.



## Enabling PTT Communication

1. Swipe up from the bottom of the Home screen and touch .
2. Slide the **Enable/Disable Switch** to the **ON** position. The button changes to **ON**.

## Selecting a Talk Group

One of 32 Talk Groups can be selected by PTT Express users. However, only one talk group may be enabled at a time on the device. Touch one of the 32 Talk Groups. The selected Talk Group is highlighted.

## PTT Communication



**NOTE:** This section describes the default PTT Express client configuration. Refer to the PTT Express V1.2 User Guide for detailed information on using the client.



**NOTE:** PTT communication may be established as a Group Call. When PTT Express is enabled, the PTT button on the left side of the device is assigned for PTT communication. When the Wired Headset is used, Group Calls can also be initiated using the headset Talk button. When using a wired headset, use only Zebra wired headsets with a PTT button.

**Figure 90** PTT Button

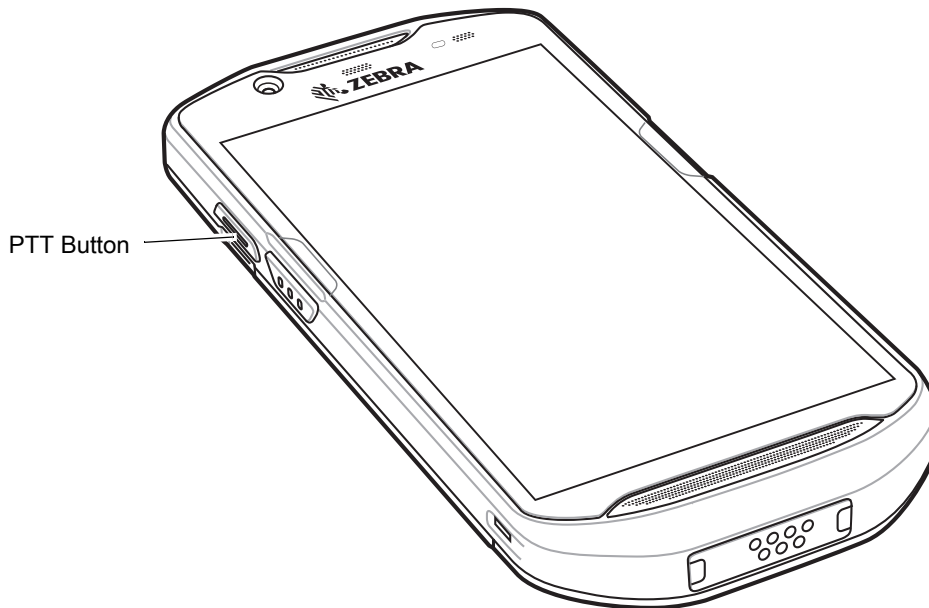

## Creating a Group Call



**NOTE:** When using a wired headset, use only Zebra wired headsets with a PTT button.

1. Press and hold the PTT button (or the Talk button on the headset) and listen for the talk tone.  
If you hear a busy tone, release the button and wait a moment before making another attempt. Ensure that PTT Express and the WLAN are enabled.

2. Start talking after hearing the talk tone.





**NOTE:** Holding the button for more than 60 seconds (default) drops the call, allowing others to make Group calls. Release the button when finished talking to allow others to make calls.

### Responding with a Private Response

The Private Response can only be initiated once a Group Call has been established. The initial Private Response is made to the originator of the Group Call.

1. Wait for an access tone.
2. Within 10 seconds, double-press the PTT button, and listen for the talk tone.
3. If you hear a busy tone, release the button and wait a moment before making another attempt. Ensure that PTT Express and the WLAN are enabled.
4. Start talking after the talk tone plays.
5. Release the button when finished talking.

### Disabling PTT Communication

1. Swipe up from the bottom of the Home screen and touch .
2. Slide the **Enable/Disable Switch** to the **OFF** position. The button changes to **OFF**.
3. Touch .

## RxLogger

RxLogger is a comprehensive diagnostic tool that provides app and system metrics. Create custom plug-ins that work seamlessly with this tool. RxLogger diagnoses device and application issues, and tracks information for: CPU load, memory load, memory snapshots, battery consumption, power states, wireless logging, cellular logging, TCP dumps, Bluetooth logging, GPS logging, logcat, ANR dumps, etc. All logs and files generated are saved in flash storage on the device (internal or external).

**Figure 91** RxLogger

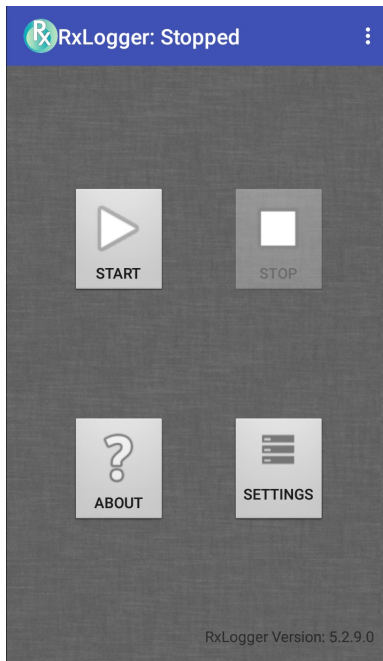

## RxLogger Utility

RxLogger Utility is a data monitoring application for viewing logs in the device while RxLogger is running. Access the logs and RxLogger Utility features in the App View or the Overlay View.

In the App View, view logs in the RxLogger Utility.

**Figure 92** RxLogger Utility App View

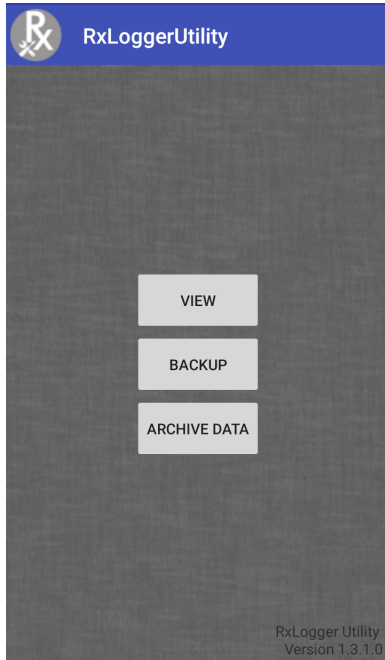

Refer to the device Integrator Guide for detailed information on the RxLogger Utility.

## SimulScan Demo

The SimulScan Demo app is an out of the box demonstration app, included on devices that support SimulScan.

The SimulScan Demo app includes the following:

- Postal, Transportation and Logistics Example - Demonstrate the Optical Character Recognition (OCR) and Optical Mark Recognition (OMR) features.
- Manufacturing Example - Demonstrate the MultiCode 20 feature.
- Demo Customization - Create a template using the Template Builder or use a default template. Test templates on the device.

**Figure 93** SimulScan Demo Home Screen

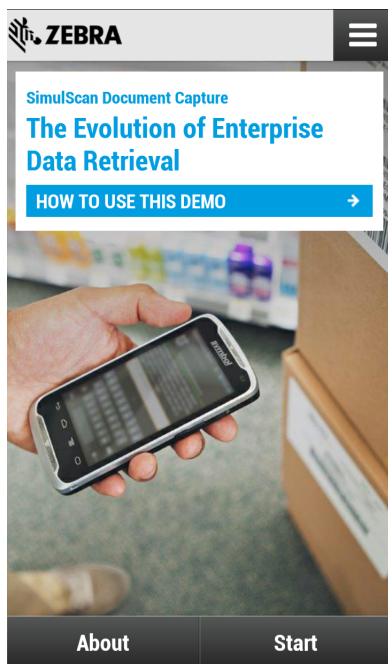

## Printing the Sample Forms

In order to perform the Postal, Transportation & Logistics or Manufacturing demonstrations, print the example forms stored on the device.

1. Launch **SimulScan Demo** application.
2. On the **SimulScan Demo** home screen, touch **HOW TO USE THIS DEMO**.
3. Scroll down and touch **Export sample forms** button. The device copies the forms to the `\simulscan\samples` folder in Internal Storage.
4. Connect the device to a computer using the USB Charging cable.
5. Copy the files from the `\simulscan\samples` folder in Internal Storage to the computer.
6. Print the forms.

## Using the Postal, Transportation and Logistics Example

1. Print the Postal, Transportation and Logistics form. See Printing the Sample Forms.

**Figure 94** Postal, Transportation and Logistics Form

1 Payer account number and insurance details		2 Non-Document Shipments Only (Customs Requirements)		
Charge to <input checked="" type="checkbox"/> Shipper <input type="checkbox"/> Receiver <input type="checkbox"/> 3rd party <small>Not all payment options are available in all countries.</small> Payer Account No. <b>001-12349876</b>		Attach the original and four copies of a Proforma or Commercial Invoice Shipper's VAT/GST number: <b>564451112</b> Receiver's VAT/GST or Shipper's EIN/SSN: <b>1111577738</b> Harmonised Commodity Code if applicable:		
Shipment Insurance see reverse <input checked="" type="checkbox"/> Yes Insurance value (in local currency) <b>1400</b>		Destination duties/taxes if left blank receiver pays duties/taxes <input type="checkbox"/> Receiver <input type="checkbox"/> Shipper <input type="checkbox"/> Other _____ <small>specify approved account number</small> Declared Value for Customs (as on commercial/proforma invoice)		
3 From (Shipper)		4 To (Receiver)		5 Shipper's agreement
Shipper's account number: <b>155-22263</b> Company name: <b>Pure Theory Ltd</b> Address: <b>163B Landedown Drive Pitzrovia, London England WC2 1AB</b> Contact name: <b>Scott Andrews</b> Phone, Fax or E-mail (required): <b>0207 553633</b>		Company name: <b>TFW Solutions</b> Delivery address: <b>Solvalla Travbaneplan 12A 64 Bromma</b> <small>We cannot deliver to a PO Box</small> Postcode/Zip Code (required): <b>286 32</b> Country: <b>Sweden</b> Contact person: <b>Aidan Peterson</b> Phone, Fax or E-mail (required): <b>+46 8 123 89 67</b>		(Signature required) <small>Unless otherwise agreed in writing, I/we agree to the Terms and Conditions of Carriage between me/us and (1) such Terms and Conditions and, where applicable, the Convention limits and/or excludes liability for loss, damage or delay and (2) this shipment does not contain cash or dangerous goods (see reverse).</small>  Signature _____ Date <b>10 / 10 / 13</b>
<small>For more information visit our website or call our local office</small>				

2. Place the form on a flat surface.
3. On the device, launch **SimulScan Demo** app.
4. Touch the **Menu** icon in the top right corner of the screen.
5. Touch **Postal, Transportation & Logistics**.
6. Touch **Start SimulScan**.
7. Use the image control at the bottom of the screen to control the flash, audio and zoom level.

**Figure 95** Image Controls

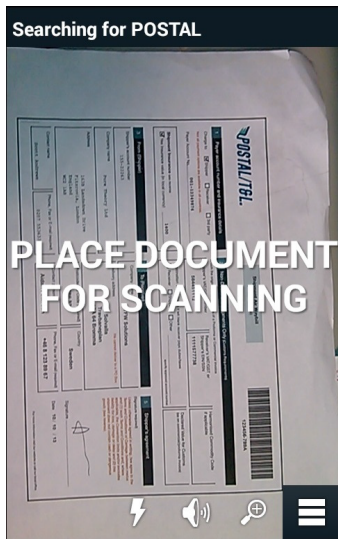

8. Position the camera over the form. Ensure that the complete border of the form is visible on the screen.
9. Hold the device steady.
10. Once the device detects the form **Tap Screen to Scan** appears on the screen.
11. Tap the screen to start the data capture. When completed, the device beeps and the data from the form displays.

**Figure 96** Postal Data Screen

POSTAL	
Field	Parsed Data
Barcode	123456-789A
Charge To	<input checked="" type="checkbox"/>
Account Number	155-22253
Shipper Name	<div style="background-color: #f08080; padding: 2px;"> <span style="color: white; font-size: 0.8em;">⚠ Check Result</span>                      Pssupcs Thckry Ltd                 </div> <div style="background-color: #d3d3d3; padding: 2px; margin-top: 2px;">                     Pure Theory Ltd                 </div>
Shipper Address	<div style="background-color: #f08080; padding: 2px;"> <span style="color: white; font-size: 0.8em;">⚠ Check Result</span>                      1538 Landsdown Drive                      lill,tgrav;la, ll;pdolrls                      England                      WC2 IAB                 </div> <div style="background-color: #d3d3d3; padding: 2px; margin-top: 2px;">                     163B Landsdown Drive                      Fitzrovia, London                      England                      WC2 IAB                 </div>
<span>RESCAN</span> <span>ACCEPT</span>	

12. Touch the text boxes to correct any errors. Note: if there are too many errors, touch **Rescan** to perform the capture again.
13. Touch **Accept** to confirm the data is correct. The **Results summary** screen appears.
14. Touch **OK**.



## Using the Manufacturing Example

1. Print the Manufacturing form. See Printing the Sample Forms.

**Figure 97** Manufacturing Form



The image shows a manufacturing form for an MSI reader. The form is white with a black border. At the top left is a purple gear icon with a white 'M' inside. To the right of this is the text 'MSI reader'. In the top right corner, there is a small black icon of a scanner and the text '<5 kgs MV unit'. Below the gear icon, the text 'PART NUMBER (P)' is followed by '5290261-69'. Underneath this is a large barcode. To the right of this barcode, the text 'SUPPLIER (V)' is followed by 'V4305156059', which is followed by another barcode. Below the first barcode, the text 'QUANTITY (Q)' is followed by '000128'. Below this is a small barcode. To the right of this, the text 'PKG ID/SERIAL NUMBER (IS)' is followed by '1SX1000114', which is followed by another small barcode. To the right of this, the text 'MADE IN MEXICO' is followed by a small barcode. At the bottom right of the form is a purple gear icon with a white 'M' inside, followed by the text 'MANUFACTURING LTD'.

2. Place the form on a flat surface.
3. On the device, launch **SimulScan Demo** app.
4. Touch the **Menu** icon in the top right corner of the screen.
5. Touch **Manufacturing**.
6. Touch **Start SimulScan**.
7. Point the top of the device at the document and center the target on the document.
8. Hold the device steady.
9. The device starts the data capture. When completed, the device beeps and the data from the document displays.

**Figure 98** Manufacturing Data

Field	Parsed Data
Part Number	P5290261-69
Supplier	V4305156059
Quantity	Q000128
Serial Number	1SX1000114
Country	

Rescan Accept

10. Touch the text boxes to correct any errors. If there are too many errors, touch **Rescan** to perform the capture again.
11. Touch **Accept** to confirm the data is correct. The **Results summary** screen appears.
12. Touch **OK**.

## Settings

To set the settings for the **SimulScan Demo** application touch **Menu** icon > **Settings**.

**Figure 99** Settings Screen

- **Volume** - Toggle switch to turn audible notification on and off.
- **Haptic** - Toggle switch to turn vibration notification on and off.
- **Debug mode** - Toggle switch to enable or disable debug mode.
- **Template server login credentials** - enter credentials for accessing the template server.

## Advanced Settings

Use the Advanced setting to configure data capture options. In the data capture screen, touch  in the bottom right corner of the screen.

Figure 100 Advanced Settings Screen



- **Identification Timeout** - Set the amount of time to wait before timing out identifying the target document. Options: **2 seconds**, **5 seconds**, **10 seconds**, **15 seconds**, **20 seconds** or **25 seconds**.
- **Processing Timeout** - Once the target document is identified, amount of time to wait before timing out processing.
- **Audio Feedback** - Turn on or off audio feedback on successful parse.
- **Haptic Feedback** - Turn on or off haptic (vibration) feedback on successful parse.
- **LED Feedback** - Turn on or off LED feedback on successful parse.
- **Debug Mode** - If enabled, allows a session to write form capture, region images, region values, and other data to storage. Use only when directed by administrator.
- **Auto Capture** - Set to **On** to automatically capture forms when detected. Set to **Off** to manually capture forms when user taps screen or presses a trigger button.
- **Image Correction** - Turn on when document is crumpled or curved and requires advanced image correction.
- **Capture Sensitivity** - Increase sensitivity for increased document identification accuracy before processing.
- **About** - Displays the SimulScan Engine version number.
- **Quit Scanner** - Exit Advanced Settings screen.

## Creating a Demo Customization

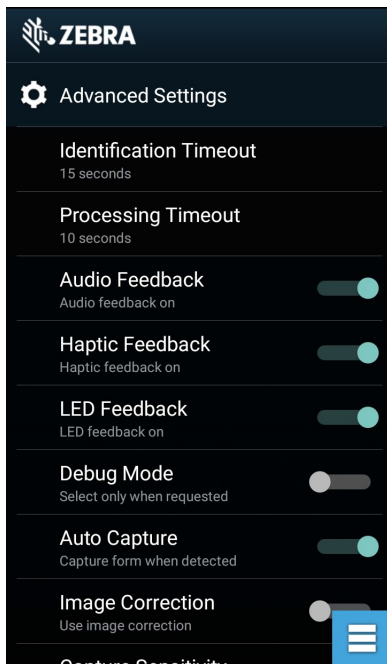
Before creating a customized demo, first:

- Create a template using the Template Builder tool.
  - Copy a company logo and image to the device storage location.
1. Touch **Menu** icon.
  2. Touch **Setup Custom Demo**.

**Figure 101** Custom Demo Setup Screen

3. In the **Name** text box, enter a name for the custom demo that appears in the drop-down menu.
4. In the **Custom Demo Setup** text box, enter a title for the demo that appears in the demo screen title box.
5. Touch the **Image** field to select an image from the SD card.
6. Touch the **Logo** field to select the logo image from the SD card.
7. In the **Introduction** text box, enter text that appears on the demo screen.
8. In the **Header color** text box, enter the hex color value for the header.
9. In the **Icon color** text box, enter the hex color value for Menu icon and button text.
10. In the **Key Features** text box, enter text that appears in bullet format under the Key Feature heading.
11. Touch one of the **SimulScan Document Capture Template** fields to select a template
  - a. **Browse external storage** - select a template loaded on the device.
  - b. **Default templates** - select one of the default templates.
  - c. **Select from server** - select a template from the SimulScan server.
12. Touch **Done**. The customized example appears on the screen.
13. Touch **Start SimulScan** to begin the demonstration.

## Default Templates

The following templates are available:

- **Default - BankCheck.xml** – Reads the MICR E-13B font (length between 19 and 40 characters) on bank checks.
- **Default - Barcode 1.xml** – Reads a single supported bar code.
- **Default - Barcode 10.xml** – Reads up to 10 supported bar codes.
- **Default - Barcode 2.xml** – Reads two supported bar codes.
- **Default - Barcode 4.xml** – Reads up to supported four bar codes.
- **Default - Barcode 5.xml** – Reads up to supported five bar codes.
- **Default - BookNumber.xml** – Reads the OCR-B ISBN 10 or 13 digit book numbers.
- **Default - DocCap + Optional Barcode** – Captures a full page image and decode any supported bar codes that are in the form. The captured area is the largest rectangular region in the field of view defined by the solid border or contrast of background. Any OCR or OMR content will not be decoded in this mode. The captured area is further processed to correct, de-skew and sharpen and returned as a picture.
- **Default - DocCap + Required Barcode** – Captures a full page image and decode of any supported bar codes that are present in the form. The captured area is the largest rectangular region in the field of view defined by the solid border or contrast of background. Any OCR or OMR content will not be decoded in this mode. The captured area is further processed to correct, de-skew and sharpen and returned as a picture.
- **Default - TravelDoc.xml** – Reads passport and Visa travel documents with OCR-B types A and B fonts.
- **Default - Unstructured Multi-Line** – Reads up to seven lines of text.
- **Default - Unstructured Single Line** – Reads a single line of text.

## Sound Recorder

Use **Sound Recorder** to record audio messages.

Recordings are saved on the microSD card (if installed) or the internal storage and are available in the Music application (non-GMS devices) or the Play Music application (GMS devices).

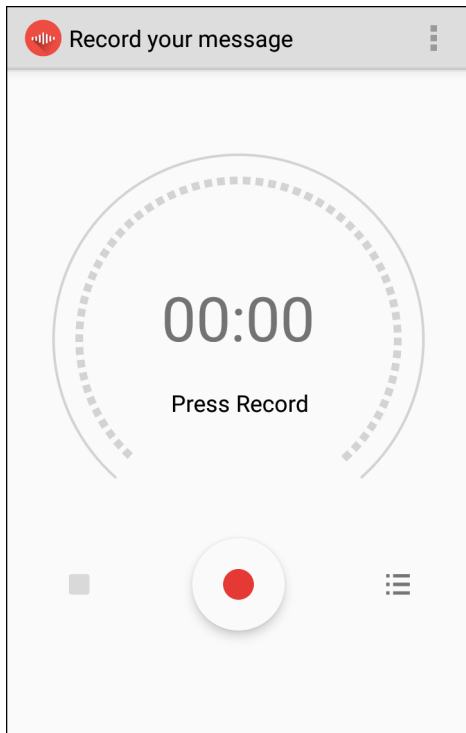
**Figure 102** Sound Recorder Application

Touch  to open options menu.

- **File type** - Select the file type for the recording file.
  - **AMR**
  - **3GPP**
  - **AAC**
  - **WAV**
  - **AMR-WR**
  - **AMR-WB-3GPP.**
- **Storage location** - Select the location for the recording file.
  - **Phone storage**
  - **SD card.**

# Data Capture

## Introduction

The device supports data capture using:

- integrated imager
- integrated camera
- RS507 Hands-free imager
- RS6000 Bluetooth Ring Scanner
- DS3678 Digital Scanner
- LI3678 Bluetooth Linear Imager Scanner
- DS2278 Digital Scanner.

## Imaging

The imager uses imaging technology to take a picture of a bar code, stores the resulting image in its memory, and executes state-of-the-art software decoding algorithms to extract the bar code data from the image. With a 2D imager, the device has the following features:

- Omnidirectional reading of a variety of bar code symbologies, including the most popular linear, postal, PDF417, and 2D matrix code types.
- Advanced intuitive laser aiming cross-hair and dot aiming for easy point-and-shoot operation.

## Digital Camera

The device with an integrated camera based barcode scanning solution has the following features:

- Omnidirectional reading of a variety of barcode symbologies, including the most popular linear, postal, QR, PDF417, and 2D matrix code types.
- Cross-hair reticle for easy point-and-shoot operation.
- Picklist mode to decode a particular barcode from many in the field of view.

The solution uses the advanced camera technology to take a digital picture of a barcode, and executes state-of-the-art software decoding algorithms to extract the data from the image.



# Linear Imager

The device with an integrated linear imager has the following features:

- Reading a variety of bar code symbologies, including the most popular 1-D code types.
- Intuitive aiming for easy point-and-shoot operation.

The imager uses imaging technology to take a picture of a bar code, stores the resulting image in its memory, and executes state-of-the-art software decoding algorithms to extract the bar code data from the image.

## Operational Modes

The device with an integrated imager supports two modes of operation, listed below. Activate each mode by pressing the Scan button.

- **Decode Mode:** In this mode, the device attempts to locate and decode enabled barcodes within its field of view. The imager remains in this mode as long as the user holds the scan button, or until it decodes a barcode.



**NOTE:** To enable Pick List Mode, configure in DataWedge or set in an application using a API command.

- **Pick List Mode:** This mode allows the user to selectively decode a barcode when more than one barcode is in the device's field of view. To accomplish this, move the aiming crosshair or dot over the required barcode to decode only this barcode. This feature is ideal for pick lists containing multiple barcodes and manufacturing or transport labels containing more than one barcode type (either 1D or 2D).

**NOTE:** To enable Basic MultiBarcode Mode, configure in DataWedge or set in an application using a API command.

- **Basic MultiBarcode Mode:** In this mode, the device attempts to locate and decode a specific number of unique barcodes within its field of view. The device remains in this mode as long as the user holds the scan button, or until it decodes all the barcodes. Available on integrated SE2100 or SE4710 imagers only.
  - The device attempts to scan the programmed number of unique barcodes (from 2 through 10).
  - If there are duplicate barcodes (same symbology type and data), only one of the duplicate barcodes is decoded and the remainder are ignored. If the label has two duplicate barcodes plus another two different barcodes, a maximum of three barcodes will be decoded from that label; one will be ignored as a duplicate.
  - Barcodes can be of multiple symbology types and still be acquired together. For example, if the specified quantity for a Basic MultiBarcode scan is four, two barcodes can be symbology type Code 128 and the other two can be symbology type Code 39.
  - If the specified number of unique barcodes is not initially in view of the device, the device will not decode any data until the device is moved to capture the additional barcode(s) or time out occurs. If the device field of view contains a number of barcodes greater than the specified quantity, the device randomly decodes barcode(s) until the specified number of unique barcodes is reached. For example, if the count is set to two and eight barcodes are in the field of view, the device decodes the first two unique barcodes it sees, returning the data in random order.
  - Basic MultiBarcode Mode does not support concatenated barcodes.

## RS507 Hands-Free Imager

The RS507 Hands-free Imager is a wearable bar code scan solution for both 1D and 2D bar code symbologies. The scanner supports Bluetooth Human Interface Device (HID) connection to the device.

**Figure 103** RS507 Hands-Free Imager

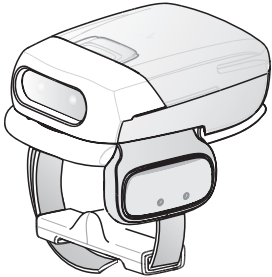

Refer to the RS507 Hands-free Imager Product Reference Guide for more information.

## RS6000 Bluetooth Ring Scanner

The RS6000 Bluetooth Ring Scanner is a wearable barcode scan solution for both 1D and 2D barcode symbologies.

**Figure 104** RS6000 Bluetooth Ring Scanner

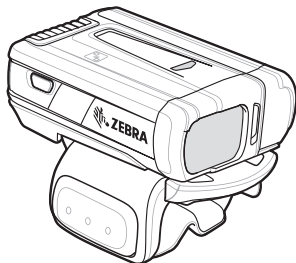

Refer to the RS6000 Bluetooth Ring Scanner Product Reference Guide for more information.

## DS3678 Digital Scanner

The cordless DS3678 combines superior 1D and 2D omnidirectional barcode scanning performance and advanced ergonomics in a lightweight design. See the DS36X8 Product Reference Guide for more information.

**Figure 105** DS3678 Digital Scanner

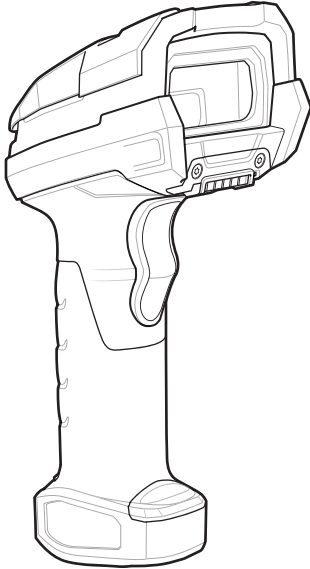

## LI3678 Linear Imager Scanner

The LI3678 cordless linear imager combines excellent scanning performance and advanced ergonomics to provide the best value in a lightweight scanner, ensuring comfort and ease of use for extended periods of time.

**Figure 106** LI3678 Linear Scanner

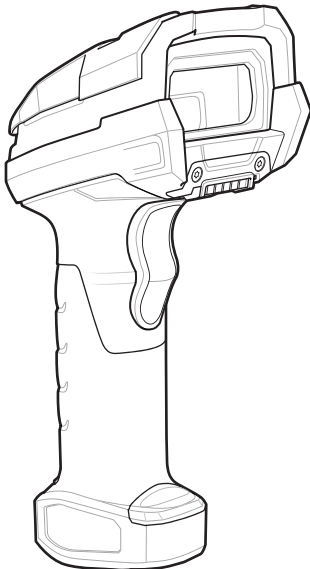

## DS2278 Digital Scanner

The DS2278 digital imager scanner scans both 1D and 2D bar codes and does not compromise performance or features.

**Figure 107** DS2278 Digital Scanner



Refer to the DS22788 Digital Scanner Product Reference Guide for more information.

## Scanning Considerations

Typically, scanning is a simple matter of aim, scan, and decode, with a few quick trial efforts to master it. However, consider the following to optimize scanning performance:

- **Range:** Scanners decode best over a particular working range — minimum and maximum distances from the barcode. This range varies according to barcode density and scanning device optics. Scan within range for quick and constant decodes; scanning too close or too far away prevents decodes. Move the scanner closer and further away to find the right working range for the barcodes being scanned.
- **Angle:** Scanning angle is important for quick decodes. When the illumination/flash reflects directly back into the imager, the specular reflection can blind/saturate the imager. To avoid this, scan the barcode so that the beam does not bounce directly back. Do not scan at too sharp an angle; the scanner needs to collect scattered reflections from the scan to make a successful decode. Practice quickly shows what tolerances to work within.
- Hold the device farther away for larger symbols.
- Move the device closer for symbols with bars that are close together.



**NOTE:** Scanning procedures depend on the app and device configuration. An app may use different scanning procedures from the one listed above.

## Scanning with Internal Imager

To read a barcode, a scan-enabled app is required. The device contains the DataWedge app that allows the user to enable the imager, decode the barcode data, and display the barcode content.

To scan with the internal imager:

1. Ensure that an app is open on the device and a text field is in focus (text cursor in text field).

2. Point the exit window on the top of the device at a barcode.

**Figure 108** Imager Scanning

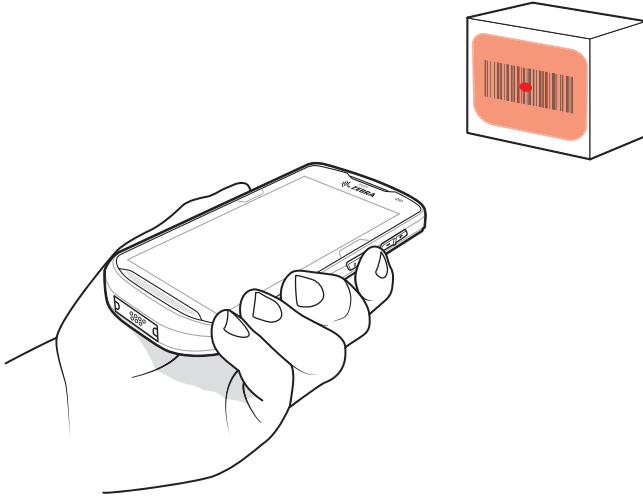

3. Press and hold the scan button.  
The red laser aiming pattern turns on to assist in aiming.



**NOTE:** When the device is in Picklist mode, the imager does not decode the barcode until the crosshair or aiming dot touches the barcode.

4. Ensure the barcode is within the area formed by the crosshairs in the aiming pattern. The aiming dot increases visibility in bright lighting conditions.

**Figure 109** Aiming Pattern

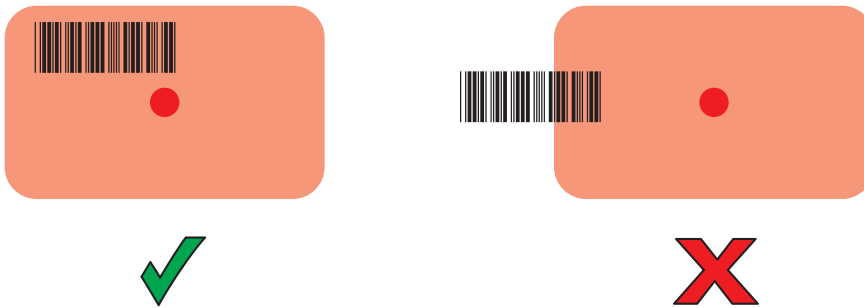

**Figure 110** Pick List Mode with Multiple Barcodes

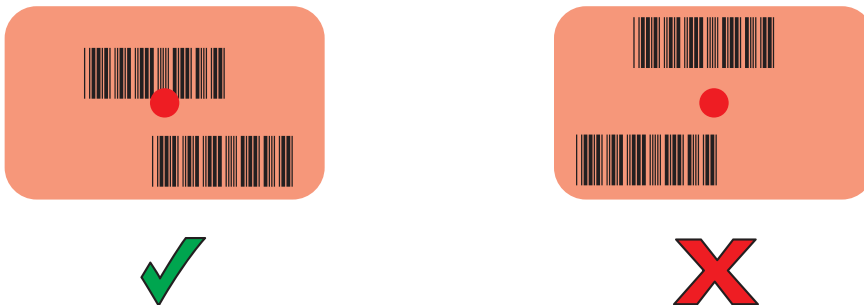

5. The Data Capture LED lights green and a beep sounds, by default, to indicate the barcode was decoded successfully.

6. Release the scan button.



**NOTE:** Imager decoding usually occurs instantaneously. The device repeats the steps required to take a digital picture (image) of a poor or difficult barcode as long as the scan button remains pressed.

7. The barcode content data displays in the text field.

## Scanning with Internal Camera

To read a barcode, a scan-enabled app is required. The device contains the DataWedge app that allows the user to enable the imager, decode the barcode data, and display the barcode content.

To scan with the internal camera:



**NOTE:** When capturing barcode data in poor lighting, turn on Illumination mode in the DataWedge application.

1. Ensure that an app is open on the device and a text field is in focus (text cursor in text field).
2. Point the camera exit window on the back of the device at a barcode.

**Figure 111** Camera Scanning

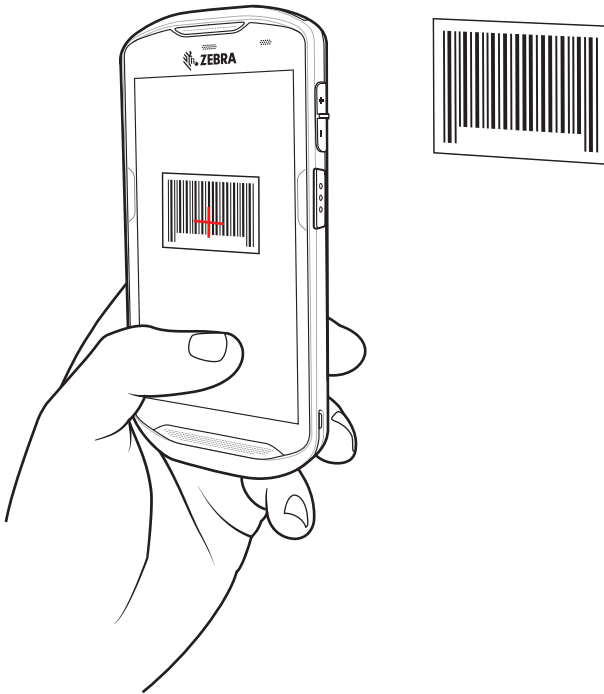

3. Press and hold the scan button. By default, a preview window appears on the screen.



**NOTE:** When Picklist mode is enabled, move the device until the bar code is centered under the red target on the screen.

4. Move the device until the barcode is visible on the screen.
5. The Decode LED lights green, a beep sounds and the device vibrates, by default, to indicate the bar code was decoded successfully.
6. The captured data appears in the text field.

## Scanning with RS6000 Bluetooth Ring Scanner

To read a barcode, a scan-enabled app is required. Devices that contain the Zebra DataWedge app allows you to enable the scanner to decode barcode data and display the barcode content.

To scan with the RS6000:

1. Pair the RS6000 with the device. See [Pairing Bluetooth Scanners](#) [Pairing Using Bluetooth Human Interface Device](#) for more information.
2. Ensure that an app is open on the device and a text field is in focus (text cursor in text field).
3. Point the RS6000 at a barcode.

**Figure 112** Barcode Scanning with RS6000

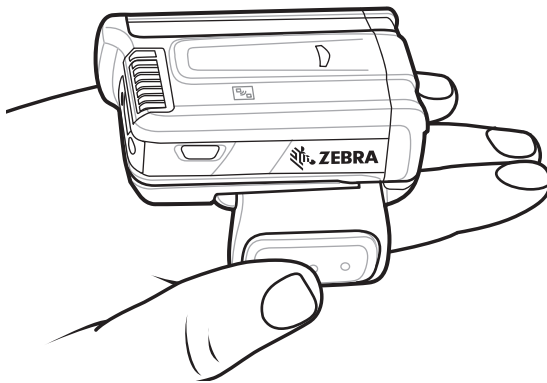

4. Press and hold the trigger.

The red laser aiming pattern turns on to assist in aiming. Ensure the barcode is within the area formed by the cross-hairs in the aiming pattern. The aiming dot increases visibility in bright lighting conditions.

The RS6000 LEDs light green and a beep sounds to indicate the barcode was decoded successfully. When the RS6000 is in Pick List mode, the RS6000 does not decode the barcode until the center of the crosshair touches the barcode.

Figure 113 RS6000 Aiming Pattern

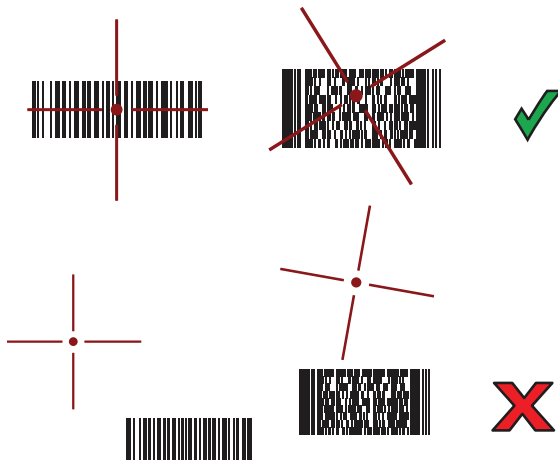

Figure 114 RS6000 Pick List Mode with Multiple Barcodes in Aiming Pattern



5. The captured data appears in the text field.

## Scanning with RS507/RS507X Hands-Free Imager

To read a barcode, a scan-enabled app is required. The device contains the DataWedge app that allows you to enable the scanner to decode barcode data and display the barcode content.

To scan with the RS507/RS507X:

1. Pair the RS507/RS507X with the device. See [Pairing Using Simple Serial Interface](#), [Pairing Bluetooth Scanners](#) or [Pairing Using Bluetooth Human Interface Device](#) for more information.
2. Ensure that an app is open on the device and a text field is in focus (text cursor in text field).



- Point the RS507/RS507X at a barcode.

**Figure 115** Barcode Scanning with RS507/RS507X

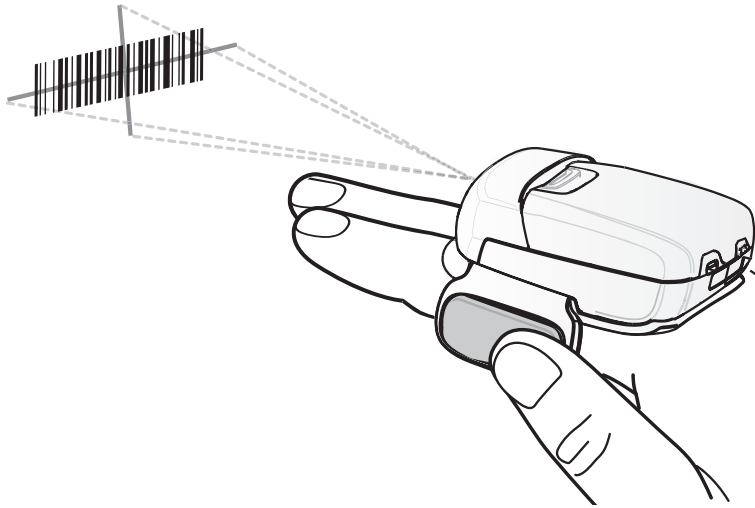

- Press and hold the trigger.

The red laser aiming pattern turns on to assist in aiming. Ensure the barcode is within the area formed by the cross-hairs in the aiming pattern. The aiming dot increases visibility in bright lighting conditions.

The RS507/RS507X LEDs light green and a beep sounds to indicate the barcode was decoded successfully. When the RS507/RS507X is in Pick List mode, the RS507/RS507X does not decode the barcode until the center of the crosshair touches the barcode.

**Figure 116** RS507/RS507X Aiming Pattern

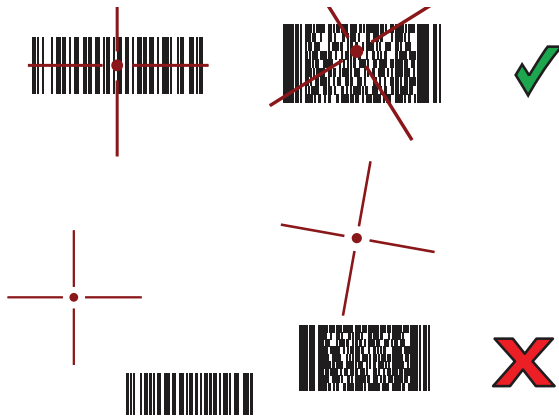

**Figure 117** RS507/RS507X Pick List Mode with Multiple Barcodes in Aiming Pattern



5. The captured data appears in the text field.

## Scanning with the DS3608 USB Scanner or DS3678 Bluetooth Scanner

To scan with the DS3608 or DS3678:

1. Pair the scanner with the device. For more information, see [Connecting a USB Scanner for the DS3608 or Pairing Bluetooth Scanners for the DS3678](#).
2. Ensure that an app is open on the device and a text field is in focus (text cursor in text field).
3. Point the scanner at a barcode.

**Figure 118** Barcode Scanning (DS3678 shown)

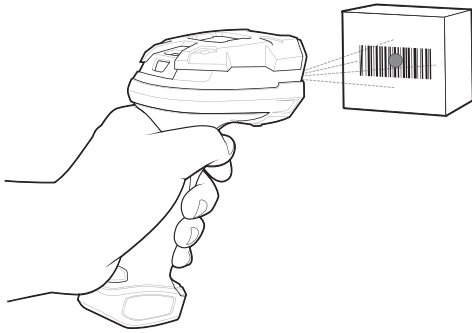

4. Press and hold the trigger.

Ensure the barcode is within the area formed by the aiming pattern. The aiming dot increases visibility in bright lighting conditions.

**Figure 119** DS3608/DS3678 Aiming Pattern

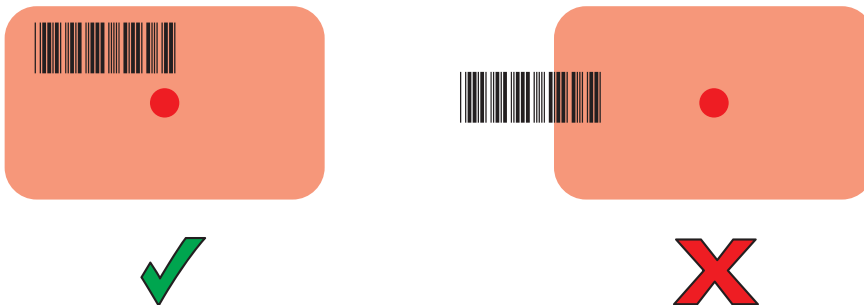

**Figure 120** DS3608/DS3678 Pick List Mode with Multiple Barcodes in Aiming Pattern

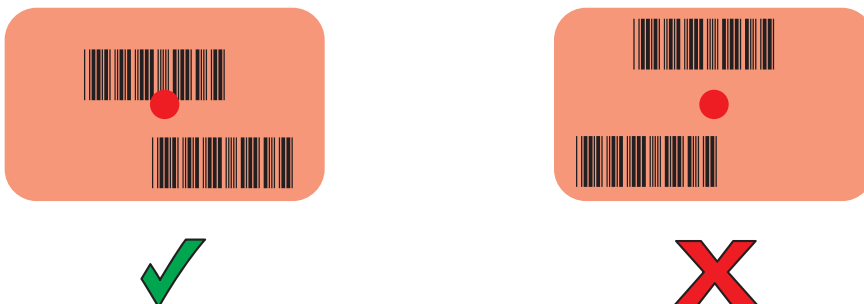

5. The captured data appears in the text field.

## Scanning with LI3678 Linear Imager

To scan with the LI3678:

1. Pair the LI3678 with the device. See [Pairing a Bluetooth Scanner on page 152](#) for more information.
2. Ensure that an app is open on the device and a text field is in focus (text cursor in text field).
3. Point the LI3678 at a barcode.

**Figure 121** Barcode Scanning with LI3678

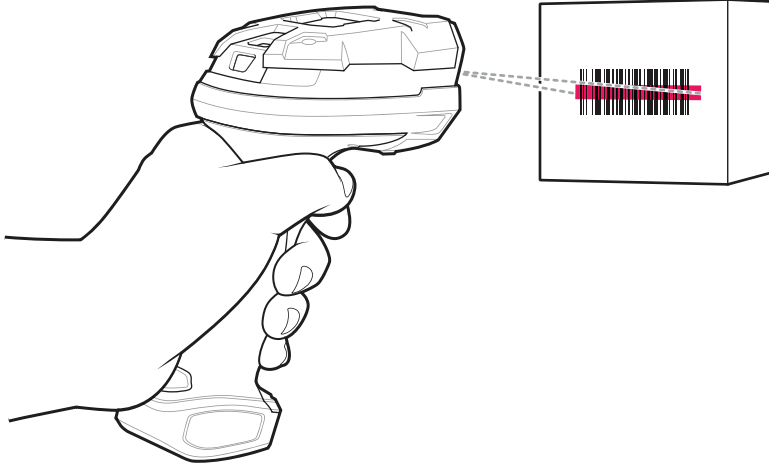

4. Press and hold the trigger.
5. Ensure the aiming pattern covers the barcode.

**Figure 122** LI3678-SR Aiming Pattern

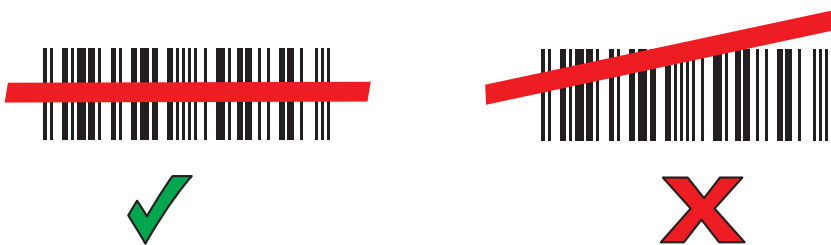

6. Upon successful decode, the scanner beeps and the LED displays a single green flash.
7. The captured data appears in the text field.

## Scanning with DS2278 Digital Scanner

To scan with the DS2278:

1. Pair the DS278 with the device. See [Pairing a Bluetooth Scanner on page 126](#) for more information.
2. Ensure that an app is open on the device and a text field is in focus (text cursor in text field).

3. Point the scanner at a barcode.

**Figure 123** Barcode Scanning with DS2278

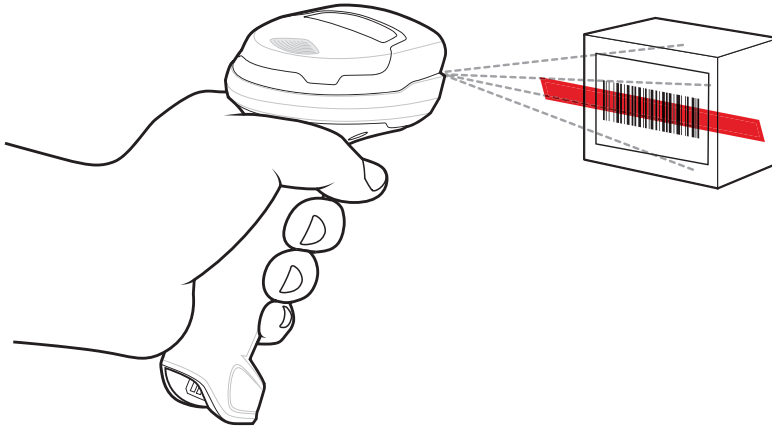

4. Press and hold the trigger.
5. Ensure the aiming pattern covers the barcode.

**Figure 124** DS2278 Aiming Pattern



6. Upon successful decode, the scanner beeps and the LED flashes, and the scan line turns off.
7. The captured data appears in the text field.

## Pairing the RS507/RS6000 Hands-Free Imager

To connect the RS507 or RS6000 imagers to the device, use one of the following methods:

- Near Field Communication (NFC) (RS6000 only)
  - Simple Serial Interface (SSI)
  - Bluetooth Human Interface Device (HID) Mode.

### Pairing in SSI Mode Using Near Field Communication

The device provides the ability to pair the RS6000 using NFC.



**NOTE:** RS6000 only.

1. Ensure that the RS6000 is in SSI mode. Refer to the RS6000 User Guide for more information.

2. Ensure that NFC is enabled on the device.
3. Align the NFC icon on the RS6000 with the NFC icon on the device battery.

The Status LED blinks blue indicating that the RS6000 is attempting to establish connection with the device. When connection is established, the Status LED turns off and the RS6000 emits a single string of low/high beeps.

A notification appears on the device screen.

The  icon appears in the Status bar.

**Figure 125** Align NFC Antennas

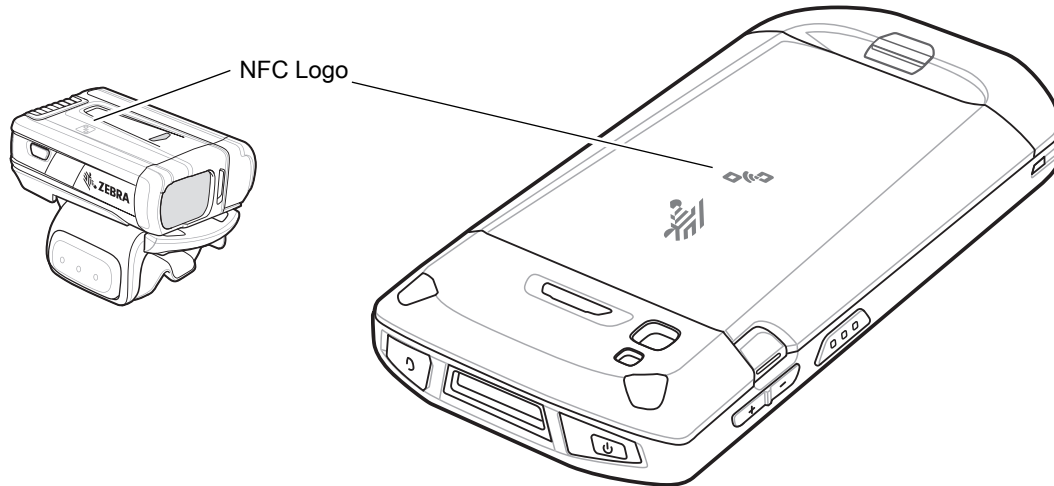

The device pairs with the RS6000 and  appears in the Status bar.



**NOTE:** Not all Zebra device support NFC readers and the Tap-to-Pair feature.

## Pairing in HID Mode Using Near Field Communication

The device provides the ability to pair the RS6000 in HID Mode using NFC.



**NOTE:** RS6000 only.

1. Ensure that NFC is enabled on the device.
2. Ensure that Bluetooth is enabled on both devices.
3. Ensure that the Bluetooth device to discover is in discoverable mode.
4. Ensure that the two devices are within 10 meters (32.8 feet) of one another.
5. Place the RS6000 in Human Interface Device (HID) mode. If the RS6000 is already in HID mode, skip to step 6.
  - a. Remove the battery from the RS6000.
  - b. Press and hold the Restore key.
  - c. Install the battery onto the RS6000.

- d. Keep holding the Restore key for about five seconds until a chirp is heard and the Scan LEDs flash green.
- e. Scan the bar code below to place the RS6000 in HID mode.

**Figure 126** Bluetooth HID Bar Code



6. Remove the battery from the RS6000.
7. Re-install the battery into the RS6000.
8. Align the NFC icon on the RS6000 with the NFC icon on the device.

The Status LED blinks blue indicating that the RS6000 is attempting to establish connection with the device. When connection is established, the Status LED turns off and the RS6000 emits a single string of low/high beeps.

A notification appears on the device screen.

The  icon appears in the Status bar.

**Figure 127** Align NFC Antennas

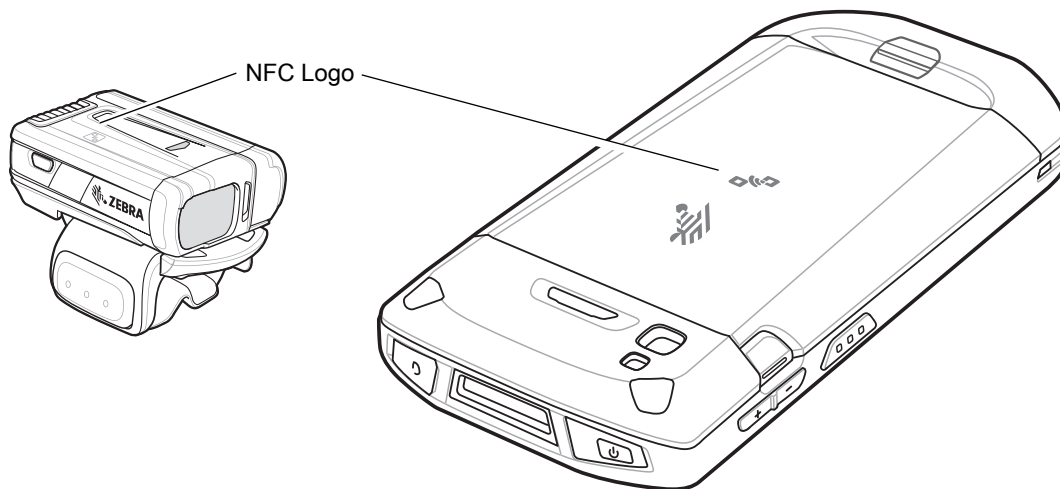

The device pairs with the RS6000 and  appears in the Status bar.



**NOTE:** RS6000 only.

## Pairing Using Simple Serial Interface



To pair the RS507/RS6000 with the device using SSI:

1. Ensure that the two devices are within 10 meters (32.8 feet) of one another.
2. Install the battery into the RS507/RS6000.

3. On the device swipe up from the bottom of the Home screen and touch .

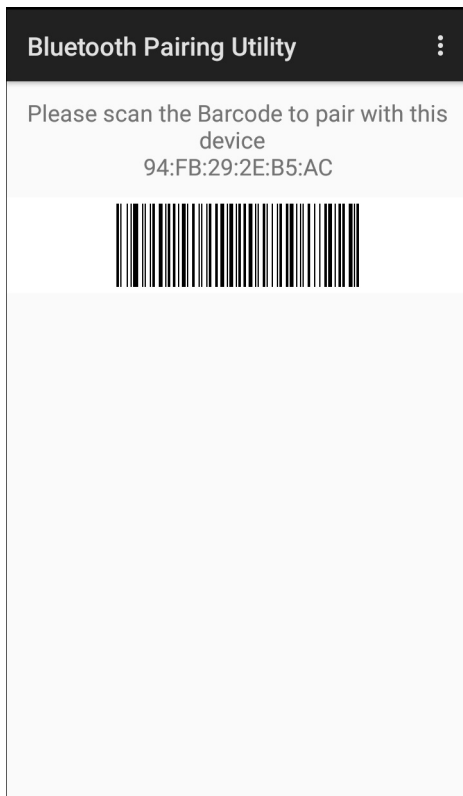
**Figure 128** Bluetooth Pairing Utility



4. Using the RS507/RS6000, scan the bar code on the screen.  
The RS507/RS6000 emits a high/low/high/low beeps. The Scan LED flashes green indicating that the RS507/RS6000 is attempting to establish connection with the device. When connection is established, the Scan LED turns off and the RS507/RS6000 emits one string of low/high beeps.  
A notification appears on the device screen and the  icon appears in the Status bar.
5. On the device touch .

## Pairing Using Bluetooth Human Interface Device

To pair the RS507/RS6000 with the device using HID:

1. Ensure that Bluetooth is enabled on both devices.
2. Ensure that the Bluetooth device to discover is in discoverable mode.
3. Ensure that the two devices are within 10 meters (32.8 feet) of one another.
4. Place the RS507/RS6000 in Human Interface Device (HID) mode. If the RS507/RS6000 is already in HID mode, skip to step 5.
  - a. Remove the battery from the RS507/RS6000.
  - b. Press and hold the Restore key.
  - c. Install the battery onto the RS507/RS6000.

- d. Keep holding the Restore key for about five seconds until a chirp is heard and the Scan LEDs flash green.
- e. Scan the bar code below to place the RS507/RS6000 in HID mode.

**Figure 129** Bluetooth HID Bar Code



5. Remove the battery from the RS507/RS6000.
6. Re-install the battery into the RS507/RS6000.
7. Swipe down with two fingers from the status bar to open the quick access panel and then touch .
8. Touch **Bluetooth**.
9. Touch **SCAN FOR DEVICES**. The device begins searching for discoverable Bluetooth devices in the area and displays them under **AVAILABLE DEVICES**.
10. Scroll through the list and select RS507/RS6000.

The device connects to the RS507/RS6000 and **Connected** appears below the device name. The Bluetooth device is added to the **Bluetooth devices** list and a trusted (“paired”) connection is established.

A notification appears on the screen and the  icon appears in the Status bar.

## Pairing a Bluetooth Scanner

Connect the scanner to the device using one of the following methods:

- Simple Serial Interface (SSI) mode
- Bluetooth Human Interface Device (HID) mode.

### Pairing Using Simple Serial Interface

To pair the scanner with the device using SSI:

1. Ensure that the two devices are within 10 meters (32.8 feet) of one another.
2. Install the battery into the scanner.



3. On the device swipe up from the bottom of the Home screen and touch .

**Figure 130** Bluetooth Pairing Utility

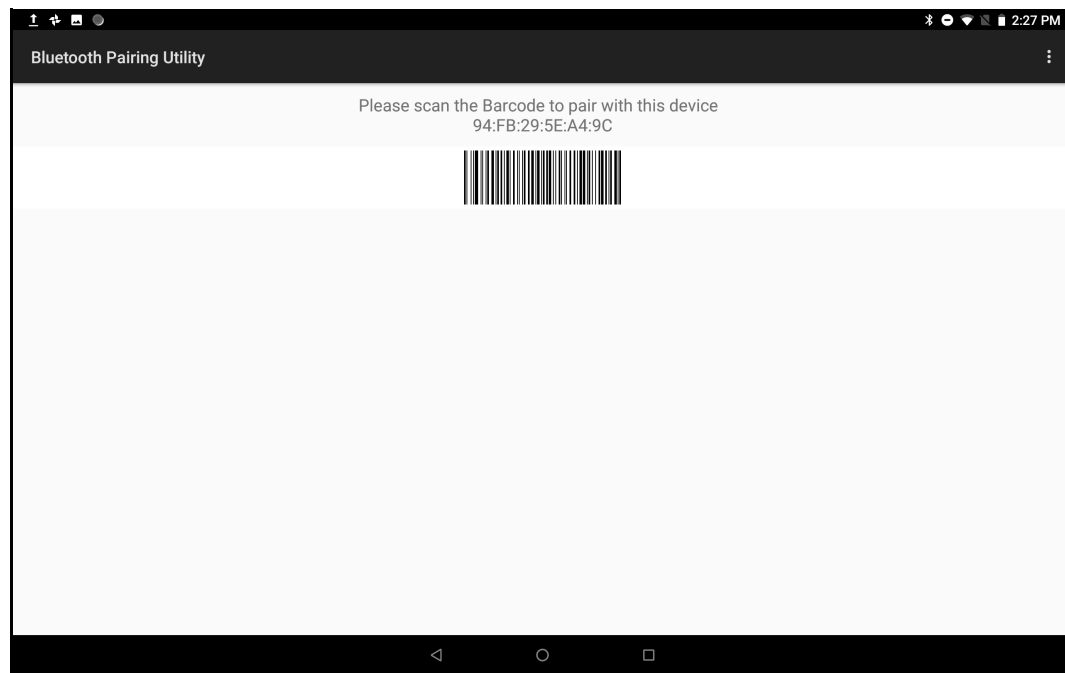
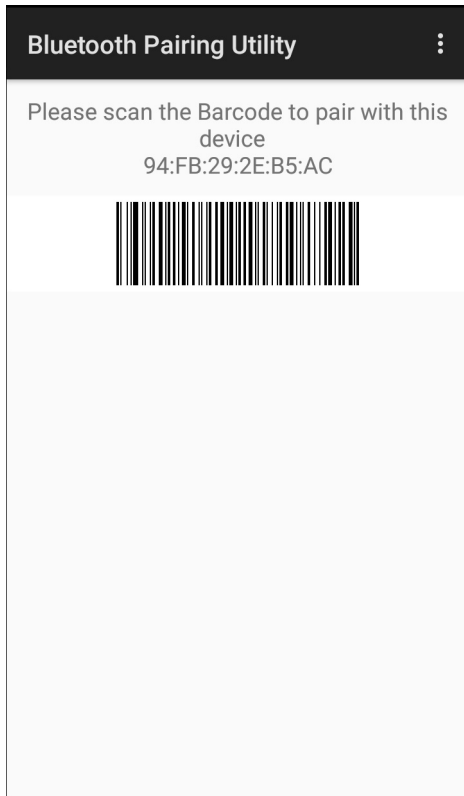

4. Using the scanner, scan the barcode on the screen.

The scanner emits a high/low/high/low beeps. The Scan LED flashes green indicating that the scanner is attempting to establish connection with the device. When connection is established, the Scan LED turns off and the scanner emits one string of low/high beeps.

5. On the device touch ○.

## Pairing Using Bluetooth Human Interface Device

To pair the scanner with the device using HID:

1. Remove the battery from the scanner.
2. Replace the battery.
3. After the scanner reboots, scan the barcode below to place the scanner in HID mode.

**Figure 131** Bluetooth HID Classic Barcode



4. On the device, swipe down from the Status bar to open the Quick Access panel and then touch ⚙️.
5. Touch **Bluetooth**.
6. Touch **Pair new device**. The device begins searching for discoverable Bluetooth devices in the area and displays them under **Available devices**.
7. Scroll through the list and select XXXXX xxxxxx, where XXXXX is the scanner and xxxxxx is the serial number.

The device connects to the scanner, the scanner beeps once and **Connected** appears below the device name. The Bluetooth device is added to the **Paired devices** list and a trusted (“paired”) connection is established.

## DataWedge



DataWedge is a utility that adds advanced barcode scanning capability to any application without writing code. It runs in the background and handles the interface to built-in barcode scanners. The captured barcode data is converted to keystrokes and sent to the target application as if it was copied and pasted, or typed on the keypad.

To configure DataWedge refer to the device Integrator Guide or Product Reference Guide.

## Enabling DataWedge

1. Swipe up from the bottom of the Home screen and touch .
2. Touch **⋮ > Settings**.
3. Touch the **DataWedge enabled** checkbox. A blue checkmark appears in the checkbox indicating that DataWedge is enabled.
4. Touch ○.

## Disabling DataWedge

1. Swipe up from the bottom of the Home screen and touch .
2. Touch  > **Settings**.
3. Touch the **DataWedge enabled** checkbox. A blue checkmark disappears from the checkbox indicating that DataWedge is disabled.
4. Touch .

# Wireless

## Introduction

This section provides information on the wireless features:

- Wireless Wide Area Network (WWAN)
- Wireless Local Area Network (WLAN)
- Bluetooth
- Near Field Communications (NFC).

## Wireless Wide Area Networks

Use Wireless wide area networks (WWANs) to access data over a cellular network. This section provides information on:

- Sharing a data connection
- Monitoring data usage.
- Changing Cellular Network settings
- Locking a SIM card.

## Sharing the Mobile Data Connection

The **Tethering & Portable Hotspot** settings allows sharing the mobile data connection with a single computer via USB tethering or Bluetooth tethering. Share the data connection with up to eight devices at once, by turning it into a portable Wi-Fi hotspot. While the device is sharing its data connection, an icon displays at the top of the screen and a corresponding message appears in the notification list.

## Enabling USB Tethering



**NOTE:** USB tethering is not supported on computers running Mac OS. If the computer is running Windows or a recent version of Linux (such as Ubuntu), follow these instructions without any special preparation. If running a version of Windows that precedes Windows 7, or some other operating system, you may need to prepare the computer to establish a network connection via USB.

1. Connect the device to a host computer with the USB cable.
2. The notification **USB charging this device** appears in the Notifications panel.
3. Swipe down from the Status bar to open the Quick Access panel and then touch .

4. Touch **Network & Internet**.
5. Touch **Hotspot & tethering**.
6. Touch the **USB tethering** switch to enable.  
The host computer is now sharing the device's data connection.

To stop sharing the data connection, touch the **USB tethering** switch again or disconnect the USB cable.

## Enabling Bluetooth Tethering

Use Bluetooth tethering to share the data connection with a host computer.

Configure the host computer to obtain its network connection using Bluetooth. For more information, see the host computer's documentation.

1. Pair the device with the host computer.
2. Swipe down from the Status bar to open the Quick Access panel and then touch .
3. Touch **Networking & Internet**.
4. Touch **Hotspot & tethering**.
5. Touch the **Bluetooth tethering** switch to enable.  
The host computer is now sharing the device's data connection.

To stop sharing the data connection, touch the **Bluetooth tethering** switch again.

## Configuring the Wi-Fi Hotspot

1. Swipe down from the Status bar to open the Quick Access panel and then touch .
2. Touch **Network & Internet**.
3. Touch **Hotspot & tethering**.

4. Touch **Set up Wi-Fi hotspot**.

**Figure 132** Set up Wi-Fi Hotspot Dialog Box

**Set up Wi-Fi hotspot**

Network name  
AndroidAP\_8525

Security  
WPA2 PSK

Password  
••••••••••

The password must have at least 8 characters.

Show password

Select AP Band  
2.4 GHz Band

CANCEL SAVE

5. In the **Network name** text field, edit the name for the hotspot.
6. Touch the **Security** option and select a security method from the drop-down list.
  - **None**
  - **WPA2 PSK**.



**NOTE:** If **None** is selected in the **Security** option, a password is not required.

7. In the **Password** text field, enter a password, if required.
8. In the **Select AP Band** drop-down list, select **2.4 GHz Band** or **5 GHz Band**.
9. Touch **Save**.

## Enabling Wi-Fi Hotspot

To enable the Wi-Fi Hotspot:

1. Swipe down from the Status bar to open the Quick Access panel and then touch .
2. Touch **Network & Internet**.
3. Touch **Hotspot & tethering**.
4. Touch the **Wi-Fi hotspot** switch to enable.

After a moment, the device starts broadcasting its Wi-Fi network name (SSID). Connect to it with up to eight computers or other devices. The Hotspot (📶) icon appears in the Status bar.

To stop sharing the data connection, touch the **Portable Wi-Fi hotspot** switch again.

## Configuring the Wi-Fi Hotspot

1. Swipe down from the Status bar to open the Quick Access panel and then touch .

2. Touch **Network & Internet**.
3. Touch **Hotspot & tethering**.
4. Touch **Set up Wi-Fi hotspot**.

**Figure 133** Set up Wi-Fi Hotspot Dialog Box

**Set up Wi-Fi hotspot**

Network name  
AndroidAP\_8525

Security  
WPA2 PSK

Password  
.....  
The password must have at least 8 characters.

Show password

Select AP Band  
2.4 GHz Band

CANCEL SAVE

5. In the **Network name** text field, edit the name for the hotspot.
6. Touch the **Security** option and select a security method from the drop-down list.
  - **None**
  - **WPA2 PSK**.



**NOTE:** If **None** is selected in the **Security** option, a password is not required.

7. In the **Password** text field, enter a password, if required.
8. In the **Select AP Band** drop-down list, select **2.4 GHz Band** or **5 GHz Band**.
9. Touch **Save**.

## Cellular Network Settings

The following sections provide settings for cellular networks.

### Disabling Data When Roaming

To prevent the device from transmitting data over other carriers' mobile networks when leaving an area that is covered by the carrier's networks. This is useful for controlling expenses if the service plan does not include data roaming.

## GSM Devices

1. Swipe down from the Status bar to open the Quick Access panel and then touch .
2. Touch **Network & Internet > Mobile network**.
3. Slide the **Roaming** switch to the off position.

### CDMA Devices

1. Swipe down from the Status bar to open the Quick Access panel and then touch .
2. Touch **Network & Internet > Mobile network > Data roaming access**.

**Figure 134** Data Roaming Access Dialog Box

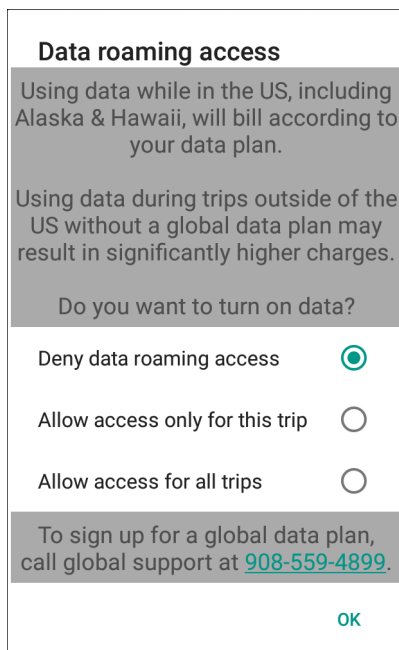

3. Select the roaming option and then touch **OK**.

### Preferred Network Type

Use to change the network operating mode.

1. Swipe down from the Status bar to open the Quick Access panel and then touch .
2. Touch **Network & Internet > Mobile network > Preferred network type**.
3. In the **Preferred network type** dialog box, select a mode to set as default:
  - **LTE only**
  - **Automatic**
  - **CDMA only**.

### Enhanced 4G LTE Mode

Use LTE services to improve voice and other communication. This option is enabled by default.





## Using Search for MicroCell

A MicroCell acts like a mini cell tower in a building or residence and connects to an existing broadband Internet service. It improves cell signal performance for voice calls, texts, and cellular data applications like picture messaging and Web surfing.

1. Swipe down from the Status bar to open the Quick Access panel and then touch .
2. Touch **Network & Internet > Mobile network**.
3. Touch **Search for AT&T MicroCell**.

## Using System Select

Use System select to change the CDMA roaming mode.





1. Swipe down from the Status bar to open the Quick Access panel and then touch .
2. Touch **Network & Internet > Mobile network > System Select**.
3. In the **System select** dialog box, select:
  - **Home only** - Do not roam from Home network.
  - **Automatic** - Allow automatic roaming.
4. Touch .

## Configuring the Access Point Name



**NOTE:** Many service provider Access Point Name (APN) data are pre-configured in the device. The APN information for all other service providers must be obtained from the wireless service provider.

To use the data on a network, configure the APN information:

1. Swipe down with two fingers from the status bar to open the quick access panel and then touch .
2. Touch **Network & Internet > Mobile network > Advanced**.
3. Touch **Access Point Names**.
4. Touch an APN name in the list to edit an existing APN or touch  to create a new APN.
5. Touch each APN setting and enter the appropriate data obtained from the wireless service provider.
6. When finished, touch  > **Save**.
7. Touch the radio button next to the APN name to start using it.
8. Touch .

## Locking the SIM Card

Locking the SIM card requires the user to enter a PIN every time the device is turned on. If the correct PIN is not entered, only emergency calls can be made.

1. Swipe down from the Status bar to open the Quick Access panel and then touch .
2. Touch **Security & location**.

3. Touch **SIM card lock**.
4. Touch **Lock SIM card**.

**Figure 135** Enter PIN to Lock SIM Card

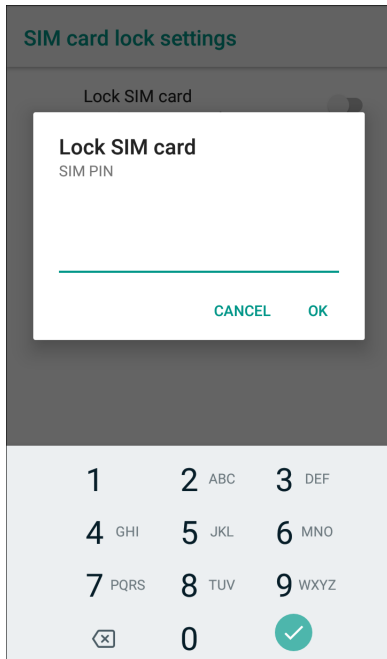

5. Enter the PIN associated with the card. Touch **OK**.
6. Reset the device.

## Data Usage

Data usage refers to the amount of data uploaded or downloaded by the device during a given period. Depending on the wireless plan, you may be charged additional fees when your data usage exceeds your plan's limit.

To monitor your data usage:

1. Swipe down from the Status bar to open the Quick Access panel and then touch **⚙️**.
2. Touch **Mobile network > Data usage > Data saver**.



**CAUTION:** The usage displayed on the data usage settings screen is measured by your device. Your carrier's data usage accounting may differ. Usage in excess of your carrier plan's data limits can result in steep overage charges. The feature described here can help you track your usage, but is not guaranteed to prevent additional charges.

Data usage settings allow:

- Set the data usage warning level.
- Set a data usage limit.
- View or restrict data usage by app.
- Identify mobile hotspots and restrict background downloads that may result in extra charges.

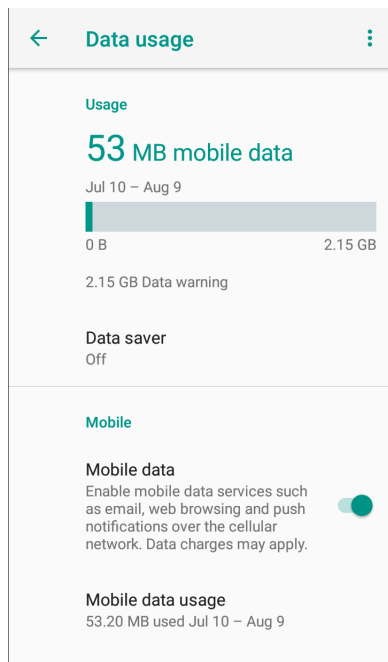

By default, the data usage settings screen displays the mobile data settings. That is, the data network or networks provided by your carrier.

**Figure 136** Data Usage Screen





## Setting Data Usage Warning

To set a warning alert when the device has used a certain amount of mobile data:

1. Swipe down from the Status bar to open the Quick Access panel and then touch .
2. Touch **Data usage**.
3. Touch **Mobile data usage** >  > **Set data warning**.
4. Touch **Data warning**.
5. Enter a number. To switch between megabytes (MB) and gigabytes (GB), touch the down arrow.
6. Touch **SET**.

When the usage reaches the set level, a notification appears.

## Setting Data Limit

1. Swipe down from the Status bar to open the Quick Access panel and then touch .
2. Touch **Data usage**.
3. Touch **Mobile data usage** >  > **Set data limit**.
4. Touch **OK**.
5. Touch **Data limit**.
6. Enter a number. To switch between megabytes (MB) and gigabytes (GB), touch the down arrow.

## 7. Touch **Set**.

When the limit is reached, data automatically turns off and a notification appears.

# Wireless Local Area Networks

Wireless local area networks (WLANs) allow the device to communicate wirelessly inside a building. Before using the device on a WLAN, the facility must be set up with the required hardware to run the WLAN (sometimes known as infrastructure). The infrastructure and the device must both be properly configured to enable this communication.

Refer to the documentation provided with the infrastructure (access points (APs), access ports, switches, Radius servers, etc.) for instructions on how to set up the infrastructure.

Once the infrastructure is set up to enforce the chosen WLAN security scheme, use the **Wireless & networks** settings configure the device to match the security scheme.

The device supports the following WLAN security options:

- Open
- Wireless Equivalent Privacy (WEP)
- Wi-Fi Protected Access (WPA)/WPA2 Personal (PSK)
- Extensible Authentication Protocol (EAP).
  - EAP-FAST - with MSCHAPV2 and GTC authentication.

The **Status** bar displays icons that indicate Wi-Fi network availability and Wi-Fi status.



**NOTE:** To extend the life of the battery, turn off Wi-Fi when not in use.

# Connecting to a Wi-Fi Network

To connect to a Wi-Fi network:

1. Swipe down from the Status bar to open the Quick Access panel.

**Figure 137** Quick Access Panel

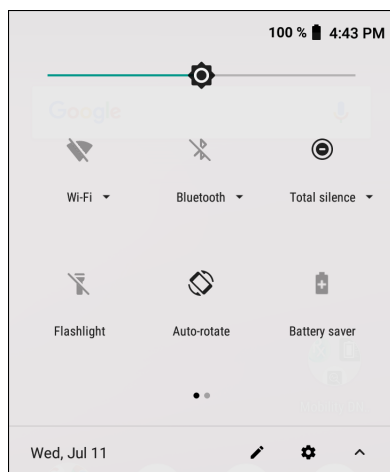

2. Touch **Wi-Fi** to open the **Wi-Fi** screen. The device searches for WLANs in the area and lists them.

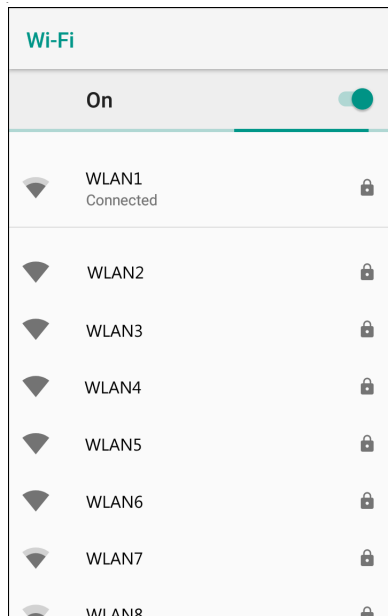

**Figure 138** Wi-Fi Screen



3. Scroll through the list and select the desired WLAN network.
4. For open networks, touch profile once or press and hold and then select **Connect to network** or for secure networks enter the required password or other credentials then touch **Connect**. See the system administrator for more information.  
The device obtains a network address and other required information from the network using the dynamic host configuration protocol (DHCP) protocol. To configure the device with a fixed internet protocol (IP) address, Refer to the device Integrator Guide for more information.
5. In the Wi-Fi setting field, **Connected** appears indicating that the device is connected to the WLAN.

## Removing a Wi-Fi Network

To remove a remembered or connected network:

1. Swipe down from the status bar to open the quick access panel and then touch .
2. Touch **Network & Internet > W-Fi**.
3. Scroll down to the bottom of the list and touch **Saved networks**.
4. Touch the name of the network.
5. In the dialog box, touch **FORGET**.
6. Touch .

## Bluetooth

Bluetooth devices can communicate without wires, using frequency-hopping spread spectrum (FHSS) radio frequency (RF) to transmit and receive data in the 2.4 GHz Industry Scientific and Medical (ISM) band

(802.15.1). Bluetooth wireless technology is specifically designed for short-range (10 m (32.8 ft)) communication and low power consumption.

Devices with Bluetooth capabilities can exchange information (for example, files, appointments, and tasks) with other Bluetooth enabled devices such as printers, access points, and other mobile devices.

The device supports Bluetooth Low Energy. Bluetooth Low Energy is targeted at applications in the healthcare, fitness, security, and home entertainment industries. It provides reduced power consumption and cost while maintaining standard Bluetooth range.

## Adaptive Frequency Hopping

Adaptive Frequency Hopping (AFH) is a method of avoiding fixed frequency interferers, and can be used with Bluetooth voice. All devices in the piconet (Bluetooth network) must be AFH-capable in order for AFH to work. There is no AFH when connecting and discovering devices. Avoid making Bluetooth connections and discoveries during critical 802.11b communications. AFH for Bluetooth consists of four main sections:

- Channel Classification - A method of detecting an interference on a channel-by-channel basis, or pre-defined channel mask.
- Link Management - Coordinates and distributes the AFH information to the rest of the Bluetooth network.
- Hop Sequence Modification - Avoids interference by selectively reducing the number of hopping channels.
- Channel Maintenance - A method for periodically re-evaluating the channels.

When AFH is enabled, the Bluetooth radio “hops around” (instead of through) the 802.11b high-rate channels. AFH coexistence allows enterprise devices to operate in any infrastructure.

The Bluetooth radio in this device operates as a Class 2 device power class. The maximum output power is 2.5 mW and the expected range is 10 m (32.8 ft). A definition of ranges based on power class is difficult to obtain due to power and device differences, and whether in open space or closed office space.



**NOTE:** It is not recommended to perform Bluetooth wireless technology inquiry when high rate 802.11b operation is required.

## Security

The current Bluetooth specification defines security at the link level. Application-level security is not specified. This allows application developers to define security mechanisms tailored to their specific need. Link-level security occurs between devices, not users, while application-level security can be implemented on a per-user basis. The Bluetooth specification defines security algorithms and procedures required to authenticate devices, and if needed, encrypt the data flowing on the link between the devices. Device authentication is a mandatory feature of Bluetooth while link encryption is optional.

Pairing of Bluetooth devices is accomplished by creating an initialization key used to authenticate the devices and create a link key for them. Entering a common personal identification number (PIN) in the devices being paired generates the initialization key. The PIN is never sent over the air. By default, the Bluetooth stack responds with no key when a key is requested (it is up to user to respond to the key request event). Authentication of Bluetooth devices is based-upon a challenge-response transaction. Bluetooth allows for a PIN or passkey used to create other 128-bit keys used for security and encryption. The encryption key is derived from the link key used to authenticate the pairing devices. Also worthy of note is the limited range and fast frequency hopping of the Bluetooth radios that makes long-distance eavesdropping difficult.

Recommendations are:

- Perform pairing in a secure environment

- Keep PIN codes private and do not store the PIN codes in the device
- Implement application-level security.

## Bluetooth Profiles

The device supports the Bluetooth services listed in the table below:

**Table 12** *Bluetooth Profiles*

Profile	Description
Service Discovery Protocol (SDP)	Handles the search for known and specific services as well as general services.
Serial Port Profile (SPP)	Allows use of RFCOMM protocol to emulate serial cable connection between two Bluetooth peer devices. For example, connecting the device to a printer.
Object Push Profile (OPP)	Allows the device to push and pull objects to and from a push server.
Advanced Audio Distribution Profile (A2DP)	Allows the device to stream stereo-quality audio to a wireless headset or wireless stereo speakers.
Audio/Video Remote Control Profile (AVRCP)	Allows the device to control A/V equipment to which a user has access. It may be used in concert with A2DP.
Personal Area Network (PAN)	Allows the use of Bluetooth Network Encapsulation Protocol to provide L3 networking capabilities over a Bluetooth link. Only PANU role is supported.
Human Interface Device Profile (HID)	Allows Bluetooth keyboards, pointing devices, gaming devices and remote monitoring devices to connect to the device.
Headset Profile (HSP)	Allows a hands-free device, such as a Bluetooth headset, to place and receive calls on the device.
Hands-Free Profile (HFP)	Allows car hands-free kits to communicate with the device in the car.
Phone Book Access Profile (PBAP)	Allows exchange of Phone Book Objects between a car kit and a mobile device to allow the car kit to display the name of the incoming caller; allow the car kit to download the phone book so you can initiate a call from the car display.
Out of Band (OOB)	Allows exchange of information used in the pairing process. Pairing is completed using the Bluetooth radio, but requires information from the OOB mechanism. Using OOB with NFC enables pairing when devices simply get close, rather than requiring a lengthy discovery process.
Symbol Serial Interface (SSI)	Allows for communication with Bluetooth Imager.
Generic Attribute Profile (GATT)	Provides profile discovery and description services for Bluetooth Low Energy protocol. It defines how attributes are grouped together into sets to form services.
Dial Up Networking (DUN)	Provides a standard to access the Internet and other dial-up services over Bluetooth.
Generic Access Profile (GAP)	Use for device discovery and authentication.
OBject EXchange (OBEX)	Facilitates the exchange of binary objects between devices.

## Bluetooth Power States

The Bluetooth radio is off by default:

- Suspend - When the device goes into suspend mode, the Bluetooth radio stays on.
- Airplane Mode - When the device is placed in Airplane Mode, the Bluetooth radio turns off. When Airplane mode is disabled, the Bluetooth radio returns to the prior state. When in Airplane Mode, the Bluetooth radio can be turned back on if desired.

## Bluetooth Radio Power

Turn off the Bluetooth radio to save power or if entering an area with radio restrictions (for example, an airplane). When the radio is off, other Bluetooth devices cannot see or connect to the device. Turn on the Bluetooth radio to exchange information with other Bluetooth devices (within range). Communicate only with Bluetooth radios in close proximity.



**NOTE:** To achieve the best battery life, turn off radios when not in use.

### Enabling Bluetooth

To enable Bluetooth:

1. Swipe down from the Status bar to open the Quick Access panel.
2. Touch  to turn Bluetooth on.
3. Touch .

### Disabling Bluetooth

To disable Bluetooth:

1. Swipe down from the Status bar to open the Quick Access panel.
2. Touch  to turn Bluetooth off.
3. Touch .

## Discovering Bluetooth Device(s)

The device can receive information from discovered devices without pairing. However, once paired, the device and a paired device exchange information automatically when the Bluetooth radio is on. To find Bluetooth devices in the area:



1. Ensure that Bluetooth is enabled on both devices.
2. Ensure that the Bluetooth device to discover is in discoverable mode.
3. Ensure that the two devices are within 10 meters (32.8 feet) of one another.
4. Swipe down from the Status bar to open the Quick Access panel.
5. Touch **Bluetooth**.
6. Touch **MORE SETTINGS**. The **Bluetooth** screen appears.



7. Touch **Pair new device**. The device begins searching for discoverable Bluetooth devices in the area and displays them under **Available devices**.
8. Scroll through the list and select a device. The Bluetooth pairing request dialog box appears.
9. Touch **Pair** on both devices.
10. The Bluetooth device is added to the **Paired devices** list and a trusted (“paired”) connection is established.

## Changing the Bluetooth Name

By default, the device has a generic Bluetooth name that is visible to other devices when connected.

1. Swipe down from the Status bar to open the Quick Access panel and then touch .
2. Touch **Connected devices > Bluetooth**.
3. If Bluetooth is not on, move the switch to turn Bluetooth on.
4. Touch **Device name**.
5. Enter a name and touch **RENAME**.
6. Touch .



## Connecting to a Bluetooth Device

Once paired, connect to a Bluetooth device.

1. Swipe down from the Status bar to open the Quick Access panel and then touch .
2. Touch **Connected device > Bluetooth**.
3. In the list, touch the unconnected Bluetooth device.  
When connected, **Connected** appears below the device name.

## Unpairing a Bluetooth Device

To unpair a Bluetooth device and erase all pairing information:

1. Swipe down from the Status bar to open the Quick Access panel and then touch .
2. Touch **Connected devices > Bluetooth**.
3. In the **Paired Devices** list, touch  next to the device name.
4. Touch **FORGET**.
5. Touch .

## Near Field Communications

NFC/HF RFID is a short-range wireless connectivity technology standard that enables secure transaction between a reader and a contactless smartcard. The technology is based on ISO/IEC 14443 type A and B (proximity) and ISO/IEC 15693 (vicinity) standards, using the HF 13.56 MHz unlicensed band. The device support 3 operating modes:

- Reader mode
- Peer-to-Peer communication
- Card Emulation mode.

Using NFC, the device can:

- Read contactless cards such as contactless tickets, ID cards and ePassport.
- Read and write information to contactless cards such as SmartPosters and tickets, as well as devices with NFC interface such as vending machines.
- Read information from supported medical sensors.
- Pair with supported Bluetooth devices such as printers and headsets.
- Exchange data with another NFC device.
- Emulate contactless card such as payment, ticket or SmartPoster.

The device NFC antenna is uniquely positioned to read NFC cards from the top of the device while being held in the user's hand.

## Reading NFC Cards

1. Launch an NFC enabled application.
2. Hold device as shown.

**Figure 139** Reading Cards

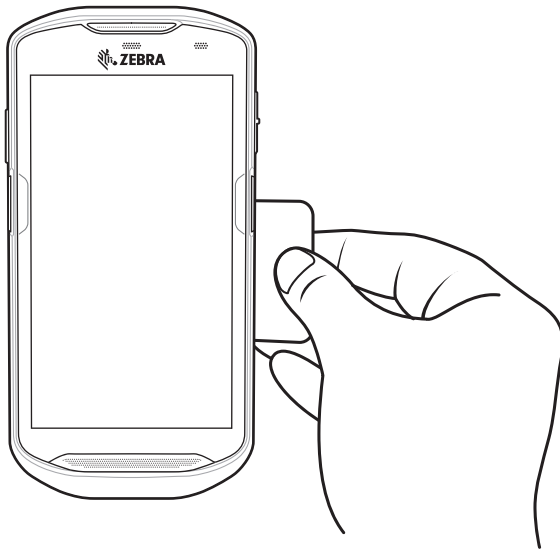

3. Move device close to the NFC card until the device detects the card.
4. Hold the card steadily until the transaction is complete (usually indicated by the application).

## Sharing Information Using NFC

You can beam content like a web page, contact cards, pictures, YouTube links or location information from your screen to another device by bringing the devices together back to back.

Make sure both devices are unlocked, support NFC, and have both NFC and Android Beam turned on.

1. Open a screen that contains a web page, video, photo or contact.
2. Move the back of the device toward the back of the other device.

**Figure 140** Sharing Data Using NFC

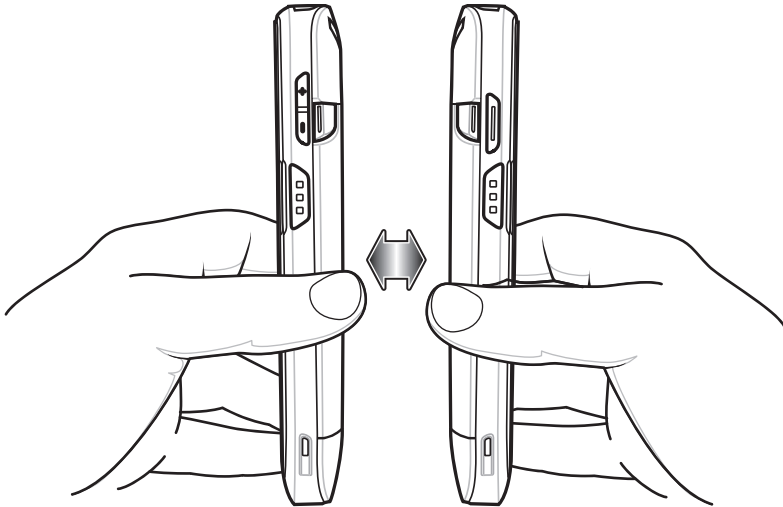

When the devices connect, you hear a sound, the image on the screen reduces in size, the message **Touch to beam** appears.

3. Touch anywhere on the screen.  
The transfer begins.

# Accessories

## Introduction

This chapter provides information for using the accessories for the device.

## Accessories

This table lists the accessories available for the device.

**Table 13** *Accessories*

Accessory	Part Number	Description
<b>Cradles</b>		
1-Slot USB/Charge Only Cradle Kit	CRD-TC51-1SCU-01	Provides device charging and communication. Includes cradle, power supply (PWR-BGA12V50W0WW) and DC line cord.
4-Slot Charge Only Cradle with Battery Charger Kit	CRD-TC51-5SC4B-01	Charges up to four devices and four spare batteries. Includes cradle, power supply (PWR-BGA12V108W0WW) and DC line cord
5-Slot Charge Only Cradle Kit	CRD-TC51-5SCHG-01	Charges up to five devices. Includes, cradle, power supply (PWR-BGA12V108W0WW) and DC line cord.
5-Slot Ethernet Cradle Kit	CRD-TC51-5SETH-01	Provides device charging and provides Ethernet communication for up to five devices. Includes cradle, power supply (PWR-BGA12V108W0WW) and DC line cord.
Cradle Mount	BRKT-SCRD-SMRK-01	Mounts the 5-Slot Charge Only Cradle, 5-Slot Ethernet Cradle, and 4-Slot Battery Charger to a wall or rack.
USB-Ethernet Adapter	KT-TC51-ETH1-01	Provides USB and Ethernet communication with the 1-Slot USB/Charge Only Cradle Kit.
<b>Batteries and Chargers</b>		
4,300 mAh (typical) / 4,050 mAh (minimum) PowerPrecisionPlus Battery	BTRY-TC51-43MA1-01 BTRY-TC51-43MA1-10	Replacement battery (single pack). Replacement battery (10-pack).

**Table 13** *Accessories (Continued)*

Accessory	Part Number	Description
4-Slot Battery Charger Kit	SAC-TC51-4SCHG-01	Charges up to four battery packs. Includes cradle, power supply (PWR-BGA12V50W0WW) and DC line cord.
<b>Vehicle Solutions</b>		
Cigarette Light Adapter Auto Charge Cable	CHG-AUTO-USB1-01	Provides power to the device from a cigarette lighter socket.
Vehicle Communication Charging Cradle	CRD-TC56-UVCD1-01	Provides power for operating the device when connected to the optional USB I/O Hub and securely holds the device.
USB I/O Hub	SHARE-USBH-01	Provides power and USB communication to the Vehicle Communication Charging Cradle. Requires power cable CHG-AUTO-CLA1-01 or CHG-AUTO-HWIRE1-01, sold separately.
ProClip Charge Only Vehicle Cradle	3PTY-PCLIP-241389	Charges and securely holds the device with Rugged Boot. Requires Hard-Wired Auto Charger Cable (3PTY-PCLIP-945081) or Cigarette Lighter Adapter (3PTY-PCLIP-945082)
ProClip Hard-Wired Auto Charger Cable	3PTY-PCLIP-945081	Provides hard-wired power to the Charge Only Vehicle Cradle (CRD-TC56-CVCD1-01) from a cigarette lighter socket.
ProClip Cigarette Light Adapter Auto Charge Cable	3PTY-PCLIP-945082	Provides power to the ProClip Charge Only Vehicle Cradle (3PTY-PCLIP-241389) from a cigarette lighter socket.
RAM Mount	RAM-B-166U	Provides mounting for vehicle cradle.
<b>Charge and Communication Cables</b>		
Rugged Charge/USB Cable	CBL-TC51-USB1-01	Provides communication and power to the device. Requires power supply PWR-WUA5V12W0xx.
Rugged USB-C Adapter	ADPTR-TC56-USBC-01	Provides communication and power to the device using a USB-C cable (CBL-TC5X-USBC2A-01).
USB-C Communication and Charge Cable	CBL-TC5X-USBC2A-01	Provides UBC-A to USB-C communication and power to the device.
USB Communication Cable	25-124330-01R	Provides micro USB to USB communication for use with 1-Slot USB/Charge Only Cradle Kit.
<b>Audio Accessories</b>		
2.5 mm Audio Adapter	CBL-TC51-HDST25-01	Plugs into the device and provides audio to a wired headset with 2.5 mm plug.
2.5 mm Headset	HDST-25MM-PTVP-01	Use for PTT and VoIP calls.
3.5 mm Audio Adapter	CBL-TC51-HDST35-01	Plugs into the device and provides audio to a wired headset with collared 3.5 mm plug.
3.5 mm Headset	HDST-35MM-PTVP-01	Use for PTT and VoIP calls.

**Table 13** *Accessories (Continued)*

Accessory	Part Number	Description
<b>Miscellaneous</b>		
Rugged Boot	SG-TC5X-EXO1-01	Provides additional protection for the device.
Trigger Handle	TRG-TC51-SNP1-01	Adds gun-style handle with a scanner trigger for comfortable and productive scanning. Requires Rugged Boot.
Trigger Handle Kit (with Rugged Boot)	TRG-TC51-TRG1-01	Adds gun-style handle with a scanner trigger for comfortable and productive scanning.
Screen Protector	KT-TC51-SCRNP1-01	Add additional screen protection.
SmartDEX Solution	DEX30	Provides wireless DEX communications to the device.
Wrist Lanyard	SG-PD40-WLD1-01	Use to hold the device on wrist. For use with Trigger Handle or Rugged Boot.
Rugged I/O Connector	ADP-TC51-RGIO1-03	Replacement Rugged I/O Connector (3-pack).
<b>Carrying Solutions</b>		
Soft Holster	SG-TC51-HLSTR1-01	Use to hold the device on hip. Accepts device with Rugged Boot and Trigger Handle
Hand Strap	SG-TC51-EHDSTP1-03	Replacement hand strap with hand strap mounting clip (3-pack).
Basic Hand Strap	SG-TC51-BHDSTP1-03	Provide a hand strap to assist in holding the device without a Rugged Boot.
Stylus and Coiled Tether	SG-TC7X-STYLUS-03	Stylus with coiled tether (3-pack).
<b>Power Supplies</b>		
Power Supply	PWR-BGA12V50W0WW	Provides power to the 1-Slot USB Charge cradle and 4-Slot Spare Battery Charger. Requires AC line cord.
Power Supply	PWR-BGA12V108W0WW	Provides power to the 4-Slot Charge Only Cradle with battery Charger, 5-Slot Charge Only cradle and the 5-Slot Ethernet Cradle. Requires DC Line Cord, p/n 50-16002-029R and country specific three wire grounded AC line cord sold separately.
Power Supply	PWR-WUA5V12W0US	Provides 12 VDC, 2.5 A power to the Rugged Charge/USB cable. Includes plug adapter for use in the United States.
Power Supply	PWR-WUA5V12W0GB	Provides 12 VDC, 2.5 A power to the Rugged Charge/USB cable. Includes plug adapter for use in the European Union.
Power Supply	PWR-WUA5V12W0EU	Provides 12 VDC, 2.5 A power to the Rugged Charge/USB cable. Includes plug adapter for use in the United Kingdom.
Power Supply	PWR-WUA5V12W0AU	Provides 12 VDC, 2.5 A power to the Rugged Charge/USB cable. Includes plug adapter for use in Australia.

**Table 13** *Accessories (Continued)*

Accessory	Part Number	Description
Power Supply	PWR-WUA5V12W0CN	Provides 12 VDC, 2.5 A power to the Rugged Charge/USB cable. Includes plug adapter for use in China.
Power Supply	PWR-WUA5V12W0IN	Provides 12 VDC, 2.5 A power to the Rugged Charge/USB cable. Includes plug adapter for use in India.
Power Supply	PWR-WUA5V12W0KR	Provides 12 VDC, 2.5 A power to the Rugged Charge/USB cable. Includes plug adapter for use in Korea.
Power Supply	PWR-WUA5V12W0BR	Provides 12 VDC, 2.5 A power to the Rugged Charge/USB cable. Includes plug adapter for use in Brazil.
DC Line Cord	CBL-DC-381A1-01	Provides power from the power supply (PWR-BGA12V108W0WW) to the 4-Slot Charge Only Cradle with Battery Charger, 5-Slot Charge Only Cradle and 5-Slot Ethernet Cradle.
DC Line Cord	CBL-DC-388A1-01	Provides power from the power supply (PWR-BGA12V50W0WW) to the 1-Slot USB/Charge Only Cradle and 4-Slot Battery Charger.
2-way DC Cable	CBL-DC-523A1-01	Connects one power supply (PWR-BGA12V108W0WW) to two 4-Slot Battery Chargers.
US AC Line Cord	23844-00-00R	Provide power to power supplies.

## 1-Slot USB Charge Cradle



**CAUTION:** Ensure that you follow the guidelines for battery safety described in Battery Safety Guidelines on page 180.

The 1-Slot USB Charge Cradle:

- Provides 5 VDC power for operating the device.
- Charges the device's battery.
- Provides USB communication with host computer.

**Figure 141** 1-Slot USB Charge Cradle

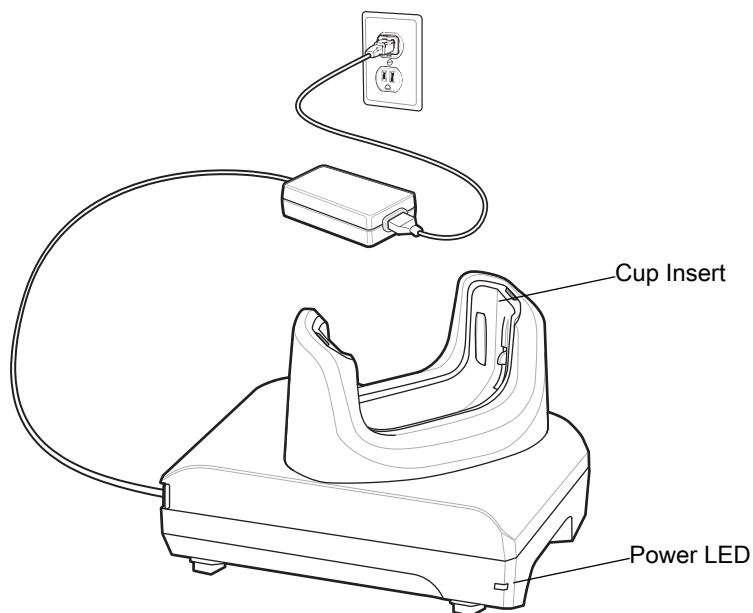

## Charging the Device

To charge a device:



**NOTE:** If the device has a Rugged Boot, remove the cup insert before inserting the device. See Integrator Guide for details.

By default, the device includes an interface connector. If the interface connector is removed for USB Type C cable connectivity, then it must be replaced before charging or receiving an Ethernet IP address if placed in a cradle.



1. Insert the device into the slot to begin charging.

**Figure 142** Battery Charging

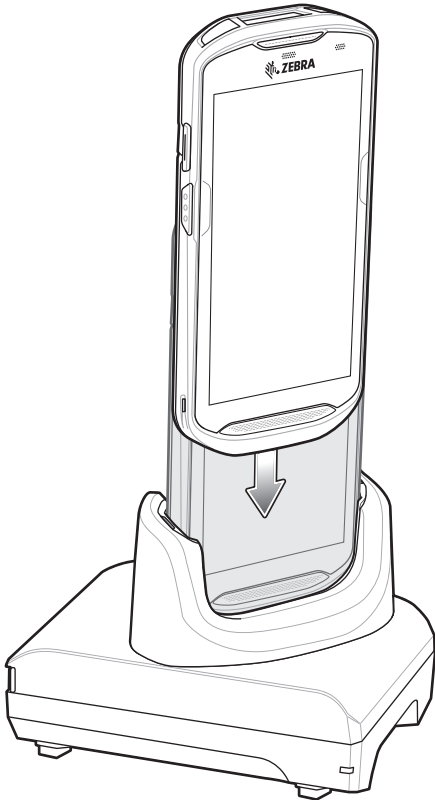

2. Ensure the device is seated properly.

## Inserting a Device with Rugged Boot into Cradle

Each cradle cup has an insert that must be removed prior to inserting the device with Rugged Boot. Remove the insert and then insert the device into the cup.

**Figure 143** Remove Insert from Cup

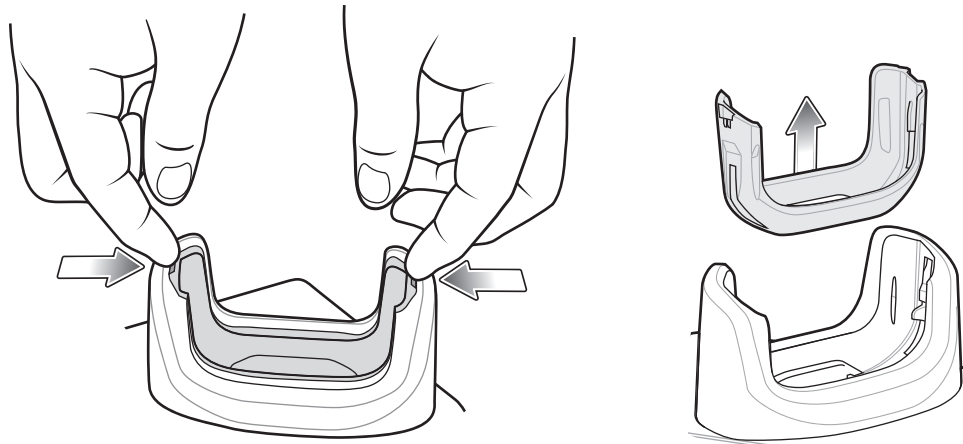

## Battery Charging

The device's Charging/Notification LED indicates the status of the battery charging in the device. See Table 3 on page 21 for device charging status. The 4,300 mAh (typical) / 4,050 mAh (minimum) battery charges from fully depleted to 90% in approximately 2.5 hours and from fully depleted to 100% in approximately three hours.



**NOTE:** In many cases the 90% charge provides plenty of charge for daily use. A full 100% charge lasts for approximately 14 hours of use.

To achieve the best fast charging results use only Zebra charging accessories and batteries. Charge batteries at room temperature with the device in sleep mode.

## Charging Temperature

Charge batteries in temperatures from 5°C to 40°C (41°F to 104°F). The device or cradle always performs battery charging in a safe and intelligent manner. At higher temperatures (e.g. approximately +37°C (+98°F)) the device or cradle may for small periods of time alternately enable and disable battery charging to keep the battery at acceptable temperatures. The device and cradle indicates when charging is disabled due to abnormal temperatures via its LED.

## 4-Slot Charge Only Cradle with Battery Charger



**CAUTION:** Ensure that you follow the guidelines for battery safety described in Battery Safety Guidelines on page 180.

The 4-Slot Charge Only Cradle with Battery Charger:

- Provides 5 VDC power for operating the device.
- Simultaneously charges up to four devices and up to four spare batteries using the Battery Charger Adapter.

**Figure 144** 4-Slot Charge Only Cradle with Battery Charger

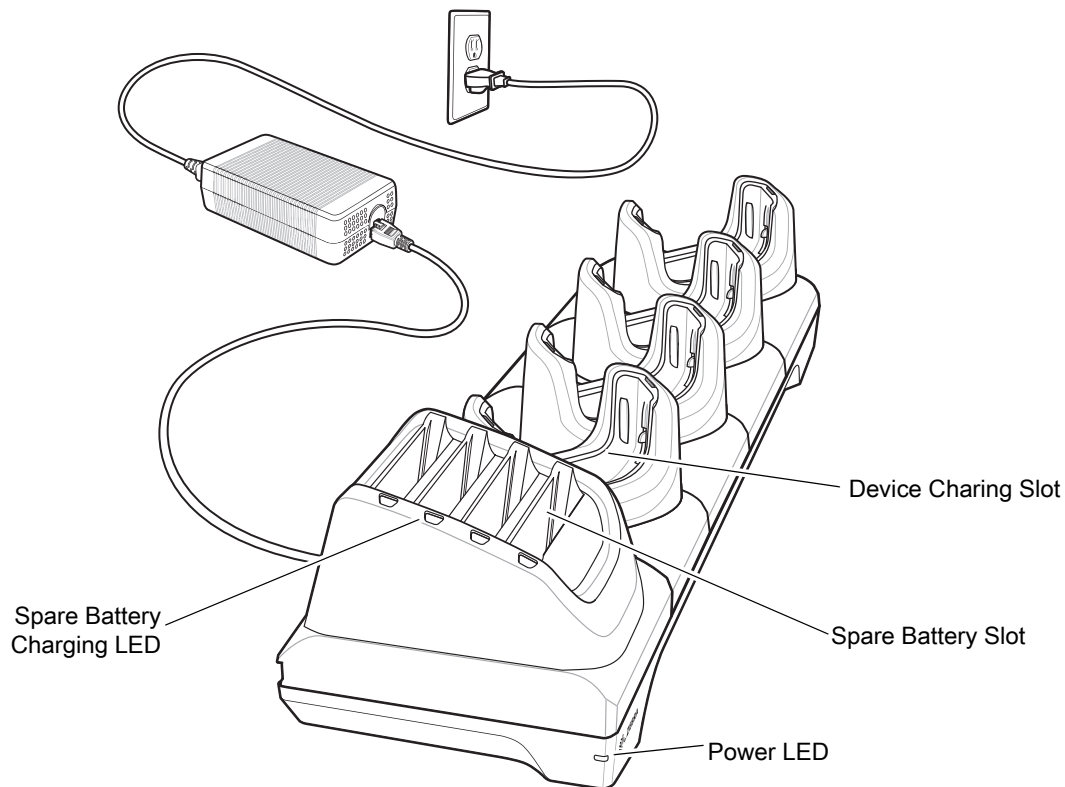

### Charging the Device

To charge a device:



**NOTE:** If the device has a Rugged Boot, remove the cup insert before inserting the device. See Integrator Guide for details.

1. Insert the device into a slot to begin charging.

**Figure 145** Device Battery Charging

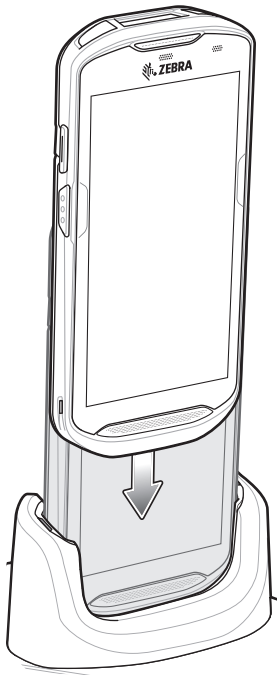

**Figure 146** Spare Battery Charging

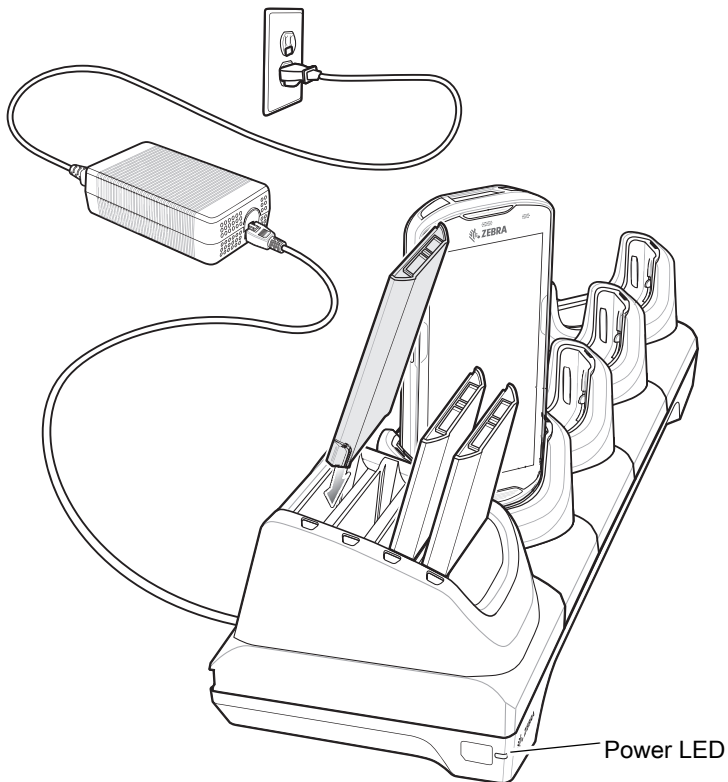

2. Ensure the device is seated properly.



**NOTE:** See the Integrator Guide for information on installing the 4-Slot Battery Charger onto the cradle.

## Inserting a Device with Rugged Boot into Cradle

Each cradle cup has an insert that must be removed prior to inserting the device with Rugged Boot. Remove the insert and then insert the device into the cup.

**Figure 147** Remove Insert from Cup

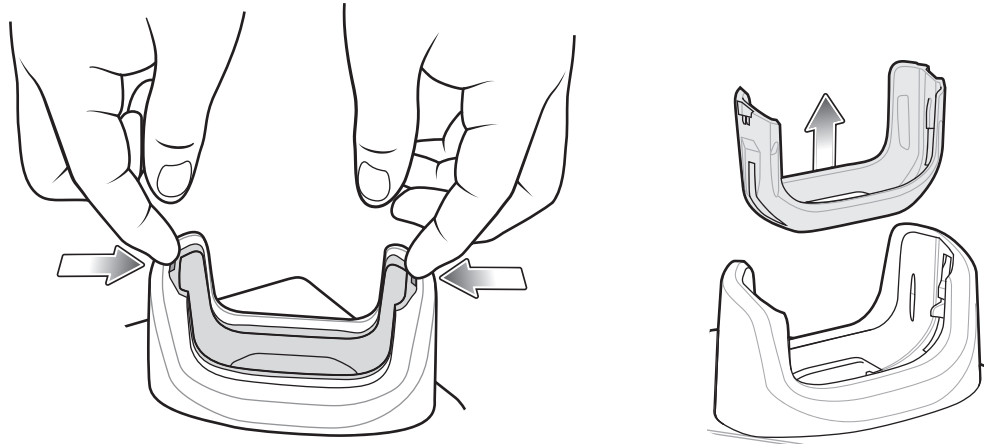

## Battery Charging

### Main Battery Charging

The device's Charging/Notification LED indicates the status of the battery charging in the device. See [Table 3 on page 21](#) for device charging status. The battery charges from fully depleted to 90% in approximately 2.5 hours and from fully depleted to 100% in approximately three hours.



**NOTE:** In many cases the 90% charge provides plenty of charge for daily use. A full 100% charge lasts for approximately 14 hours of use.

To achieve the best fast charging results use only Zebra charging accessories and batteries. Charge batteries at room temperature with the device in sleep mode.

### Spare Battery Charging







The Spare Battery Charging LED on the cup indicates the status of the spare battery charging. The battery charges from fully depleted to 90% in approximately 2.3 hours and from fully depleted to 100% in approximately three hours.



**NOTE:** In many cases the 90% charge provides plenty of charge for daily use. A full 100% charge lasts for approximately 14 hours of use.

To achieve the best fast charging results use only Zebra charging accessories and batteries.

**Table 14** Spare Battery LED Charging Indicators

LED	LED	Indication
Solid amber		Spare battery is charging.
Solid amber with alternate bright amber		Best spare battery is charging.
Solid Green		Spare battery charging is complete.
Solid Green with alternate bright green		Best spare battery charging is complete.
Solid Red		Spare battery is charging and battery is at the end of useful life. Charging complete and battery is at the end of useful life.
Fast Blinking Red (2 blinks/second)		Error in charging; check placement of spare battery and battery is at the end of useful life.
Off		No spare battery in slot. Spare battery not placed in slot correctly. Cradle is not powered.

## Charging Temperature

Charge batteries in temperatures from 5°C to 40°C (41°F to 104°F). The device or cradle always performs battery charging in a safe and intelligent manner. At higher temperatures (e.g. approximately +37°C (+98°F)) the device or cradle may for small periods of time alternately enable and disable battery charging to keep the battery at acceptable temperatures. The device and cradle indicates when charging is disabled due to abnormal temperatures via its LED.

## 5-Slot Charge Only Cradle



**CAUTION:** Ensure that you follow the guidelines for battery safety described in Battery Safety Guidelines on page 180.

The 5-Slot Charge Only Cradle:

- Provides 5 VDC power for operating the device.
- Simultaneously charges up to five devices.

**Figure 148** 5-Slot Charge Only Cradle

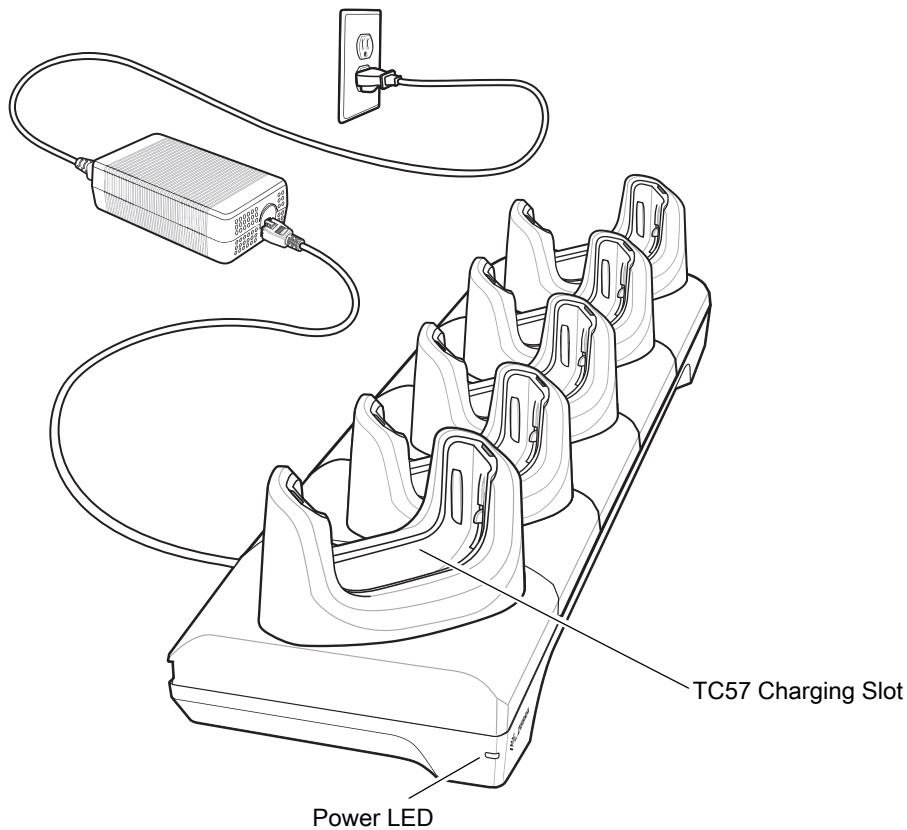

## Charging the Device

To charge a device:



**NOTE:** If the device has a Rugged Boot, remove the cup insert before inserting the device. See TC57 Touch Computer Integrator Guide for Android 8.1.0 Oreo for details.

1. Insert the device into a slot to begin charging.

**Figure 149** TC57 Battery Charging

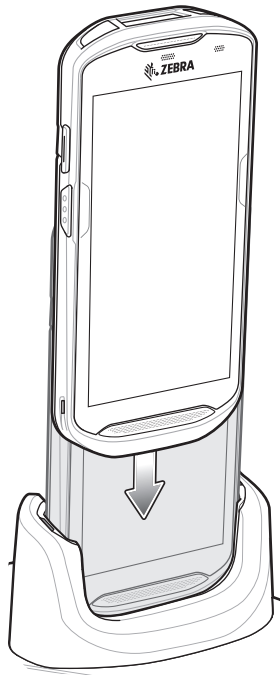

2. Ensure the device is seated properly.



**NOTE:** See the TC57 Touch Computer Integrator Guide for Android 8.1.0 Oreo for information on installing the 4-Slot Battery Charger onto the cradle.

## Inserting a Device with Rugged Boot into Cradle

Each cradle cup has an insert that must be removed prior to inserting the device with Rugged Boot. Remove the insert and then insert the device into the cup.

**Figure 150** Remove Insert from Cup

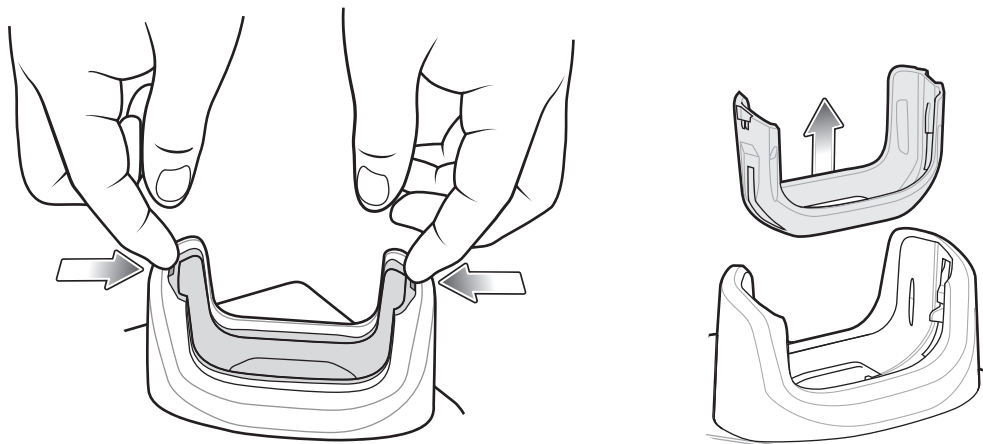



## Battery Charging

### Main Battery Charging

The device's Charging/Notification LED indicates the status of the battery charging in the device. See [Table 3 on page 21](#) for device charging status. The battery charges from fully depleted to 90% in approximately 2.5 hours and from fully depleted to 100% in approximately three hours.



**NOTE:** In many cases the 90% charge provides plenty of charge for daily use. A full 100% charge lasts for approximately 14 hours of use.

To achieve the best fast charging results use only Zebra charging accessories and batteries. Charge batteries at room temperature with the device in sleep mode.

### Charging Temperature

Charge batteries in temperatures from 5°C to 40°C (41°F to 104°F). The device or cradle always performs battery charging in a safe and intelligent manner. At higher temperatures (e.g. approximately +37°C (+98°F)) the device or cradle may for small periods of time alternately enable and disable battery charging to keep the battery at acceptable temperatures. The device and cradle indicates when charging is disabled due to abnormal temperatures via its LED.

## 5-Slot Ethernet Cradle

The 5-Slot Ethernet Cradle:

- Provides 5 VDC power for operating the device.
- Connects the device (up to five) to an Ethernet network.
- Simultaneously charges up to five devices.

**Figure 151** 5-Slot Ethernet Cradle

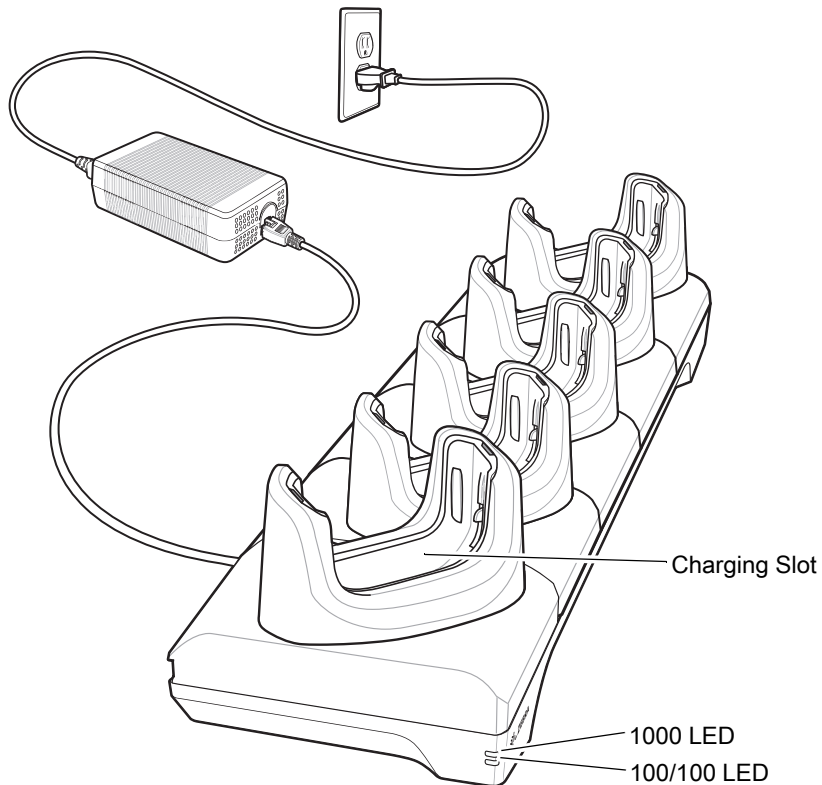

## Charging the Device

To charge a device:



**NOTE:** If the device has a Rugged Boot, remove the cup insert before inserting the device. See TC57 Touch Computer Integrator Guide for Android 8.1.0 Oreo for details.

1. Insert the device into a slot to begin charging.

**Figure 152** TC57 Battery Charging

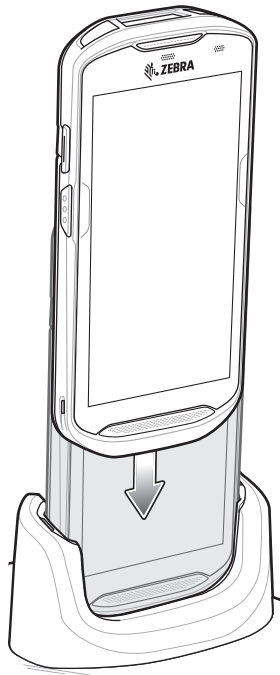

2. Ensure the device is seated properly.

## Inserting a TC57 with Rugged Boot into Cradle

Each cradle cup has an insert that must be removed prior to inserting the device with Rugged Boot. Remove the insert and then insert the device into the cup.

**Figure 153** Remove Insert from Cup

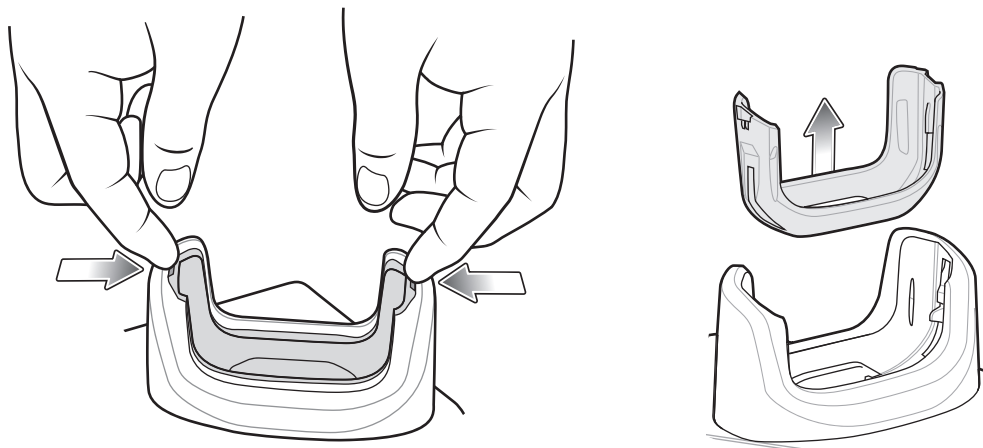

## Battery Charging

### Main Battery Charging

The device's Charging/Notification LED indicates the status of the battery charging in the device. See [Table 3 on page 21](#) for device charging status. The battery charges from fully depleted to 90% in approximately 2.5 hours and from fully depleted to 100% in approximately three hours.



**NOTE:** In many cases the 90% charge provides plenty of charge for daily use. A full 100% charge lasts for approximately 14 hours of use.

To achieve the best fast charging results use only Zebra charging accessories and batteries. Charge batteries at room temperature with the device in sleep mode.



### Charging Temperature

Charge batteries in temperatures from 5°C to 40°C (41°F to 104°F). The device or cradle always performs battery charging in a safe and intelligent manner. At higher temperatures (e.g. approximately +37°C (+98°F)) the device or cradle may for small periods of time alternately enable and disable battery charging to keep the battery at acceptable temperatures. The device and cradle indicates when charging is disabled due to abnormal temperatures via its LED.

### Establishing Ethernet Connection



**NOTE:** Refer to the TC57 Touch Computer Integrator Guide for Android 8 Oreo for information on configuring the Ethernet settings.

1. Swipe down with two fingers from the status bar to open the quick access panel and then touch .
2. Touch **Ethernet**.
3. Slide the Ethernet switch to the **ON** position.
4. Insert the device into a slot.  
The  icon appears in the Status bar.
5. Touch **Eth0** to view Ethernet connection details.

## LED Indicators

There are two green LEDs on the side of the cradle. These green LEDs light and blink to indicate the data transfer rate.

**Table 15** LED Data Rate Indicators

Data Rate	1000 LED	100/10 LED
1 Gbps	On/Blink	Off
100 Mbps	Off	On/Blink
10 Mbps	Off	On/Blink

## 4-Slot Battery Charger



**CAUTION:** Ensure that you follow the guidelines for battery safety described in Battery Safety Guidelines on page 180.

This section describes how to use the 4-Slot Battery Charger to charge up to four device batteries.

### Charging Spare Batteries

1. Connect the charger to a power source.
2. Insert the battery into a battery charging well and gently press down on the battery to ensure proper contact.

**Figure 154** 4-Slot Battery Charger

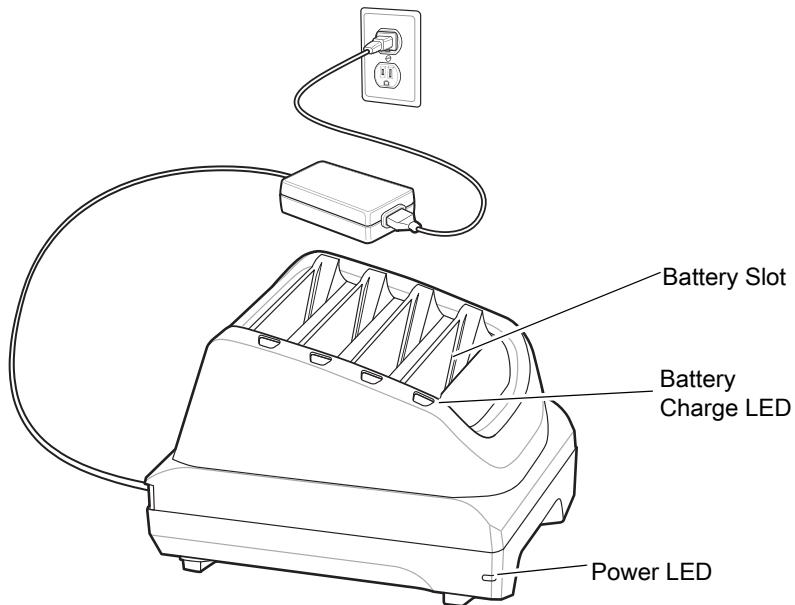

## Battery Charging

### Spare Battery Charging

Figure 155 Insert Battery into Charger

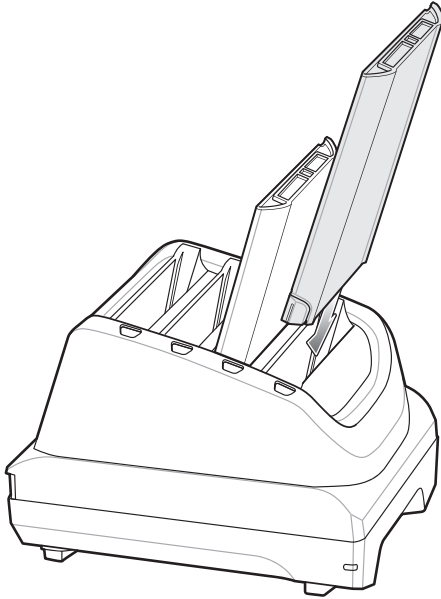

Each Battery Charging LED indicates the status of the battery charging in each slot. See Table 14 on page 182 for spare battery charging indicator descriptions.

The 4,300 mAh (typical) / 4,050 mAh (minimum) battery charges from fully depleted to 90% in approximately 2.3 hours and from fully depleted to 100% in approximately three hours.



**NOTE:** In many cases the 90% charge provides plenty of charge for daily use. A full 100% charge lasts for approximately 14 hours of use.

To achieve the best fast charging results use only Zebra charging accessories and batteries.

### Charging Temperature

Charge batteries in temperatures from 5°C to 40°C (41°F to 104°F). The device or cradle always performs battery charging in a safe and intelligent manner. At higher temperatures (e.g. approximately +37°C (+98°F)) the device or cradle may for small periods of time alternately enable and disable battery charging to keep the battery at acceptable temperatures. The device and cradle indicates when charging is disabled due to abnormal temperatures via its LED.

## Rugged Boot

The Rugged Boot provides additional protection for the device.

### Installation

To install the Rugged Boot:

1. Insert the bottom of the device into the bottom of the boot.

**Figure 156** Insert Device into Boot

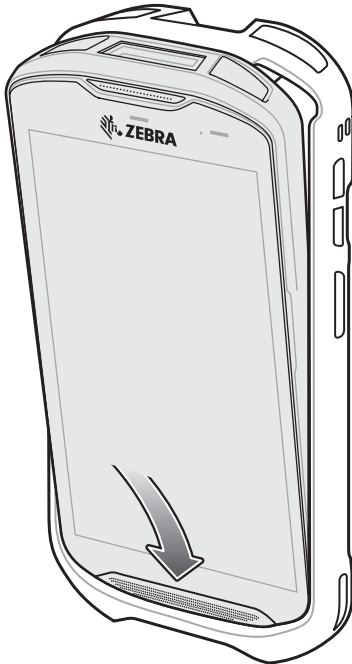

2. Lift the top of the Rugged Boot over the top of the device.

**Figure 157** Lift Boot Over Device



3. Push the device into the Rugged Boot.

**Figure 158** Push Device into Boot

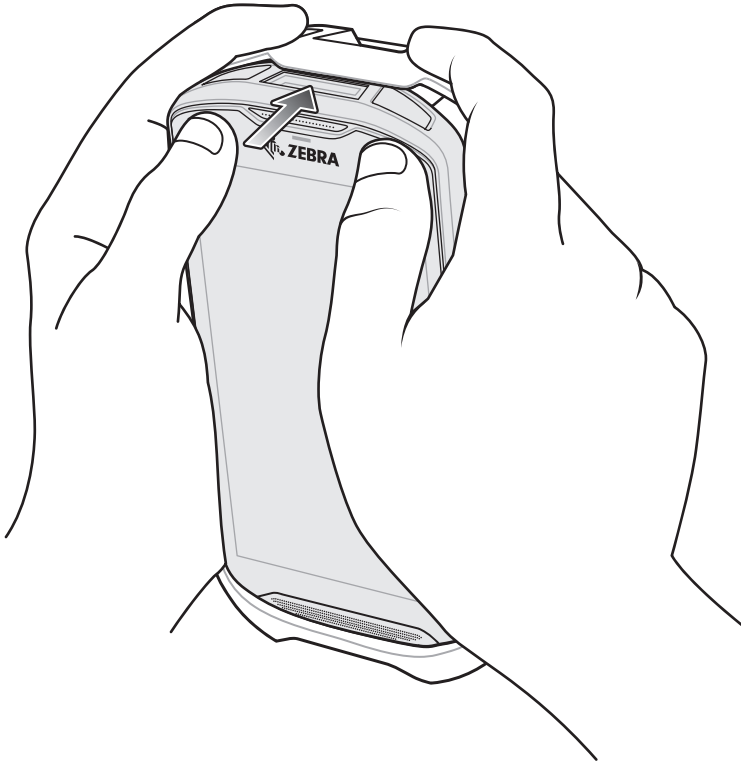

## Installing Stylus

To install the optional stylus:

1. Insert one of the loop ends of the tether through the hole in the stylus.
2. Feed the tether through the loop.
3. Pull the tether until the loop tightens.
4. Insert the loop into the hand strap holder.



5. Feed the stylus through the loop.

**Figure 159** Install Tether to Stylus

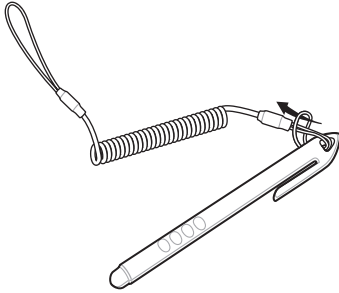

**Figure 160** Install Stylus on Hand Strap

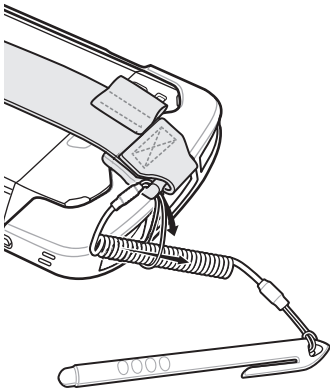

## Charging with Cradles

Before inserting the device with the Rugged Boot into the cradle cup, remove the insert from the cup.

1. Using index fingers on both hands, push the insert toward the center of the cup.

**Figure 161** Pull Insert Toward Center

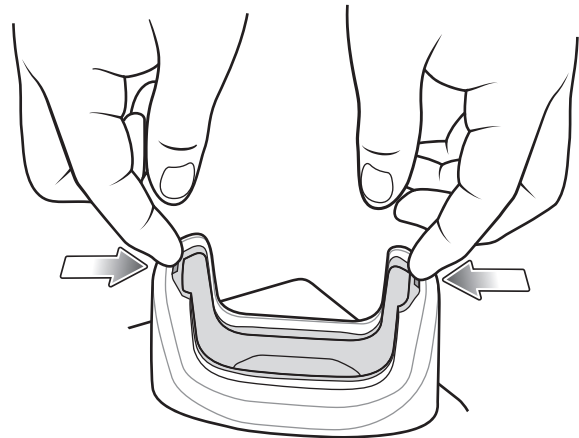

2. Lift insert out of cup.

**Figure 162** Lift Insert Out of Cup

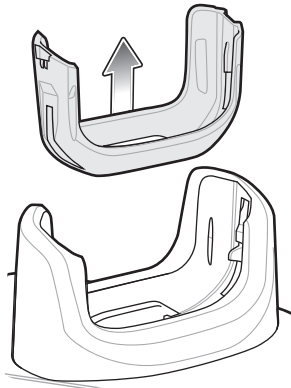

3. Insert the device into the cradle.

**Figure 163** Insert Device with Boot into Cradle Cup

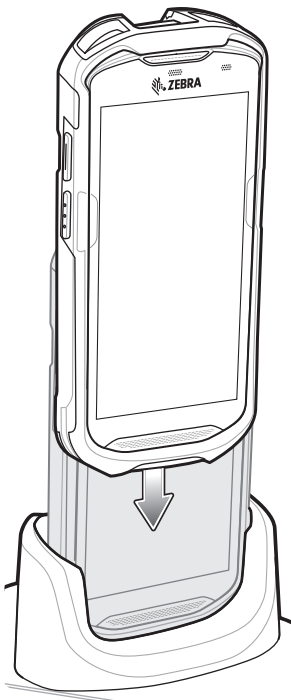

## 2.5 mm Audio Adapter



**NOTE:** The Audio Adapter is available for the device standard configuration.

The 2.5 mm Audio Adapter plugs into the device and connects to a wired headset with a 2.5 mm plug.

To attach a 2.5 mm headset:

1. Open the headset jack cover.
2. Insert the 2.5 mm Audio Adapter plug into the headset jack.

**Figure 164** Audio Adapter Installation



3. Insert the 2.5 mm headset plug into the jack on the Audio Adapter.

**Figure 165** Connect Headset to Audio Adapter

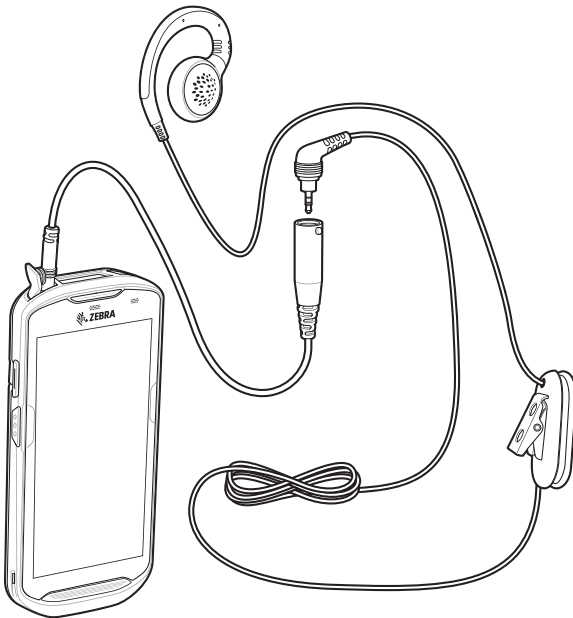

**CAUTION:** After removing headset, headset jack cover must be replaced and securely seated to ensure proper device sealing.

## 3.5 mm Audio Adapter



**NOTE:** The Audio Adapter is available for the device standard configuration.

The 3.5 mm Audio Adapter plugs into the device and connects to a wired headset with a 3.5 mm plug.

To attach a 3.5 mm headset:

1. Open the headset jack cover.
2. Insert the 3.5 mm Audio Adapter plug into the headset jack.

**Figure 166** Audio Adapter Installation



3. Connect the 3.5 mm connector plug of the headset into the 3.5 mm Audio Adapter.

**Figure 167** Connect Headset to 3.5 mm Adapter Cable

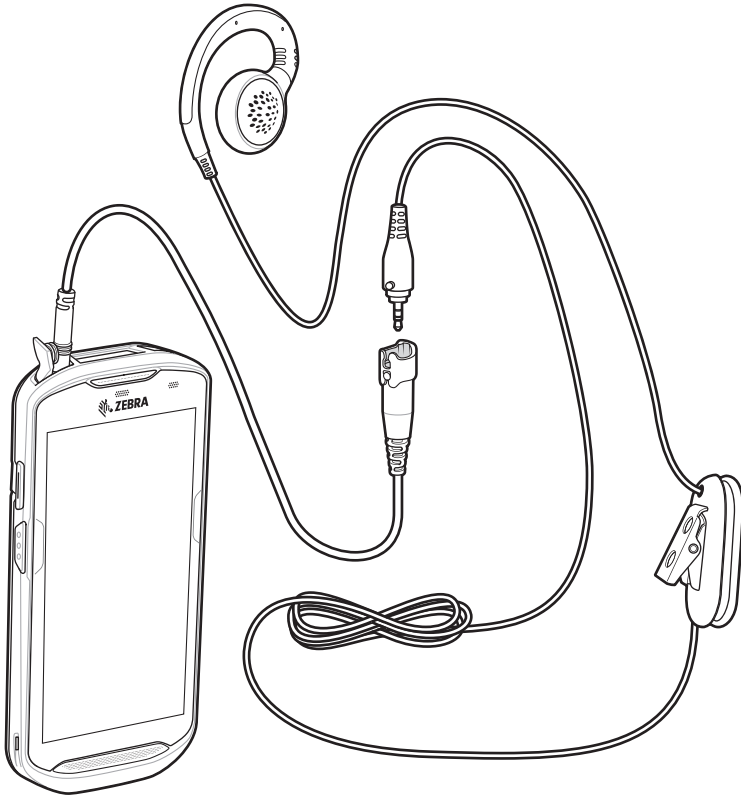

**CAUTION:** After removing headset, headset jack cover must be replaced and securely seated to ensure proper device sealing.

## Rugged Charge/USB Cable

The Rugged Charge/USB Cable snaps onto the bottom of the device and removes easily when not in use. When attached to the device allows charging and allows the device to transfer data to a host computer.

**Figure 168** Rugged Charge/USB Cable

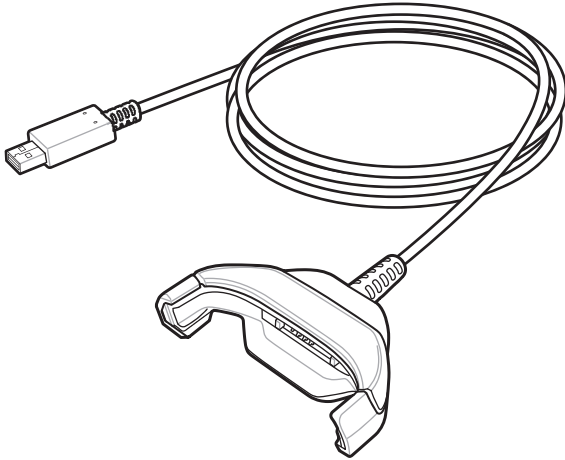

## Connecting to TC57

1. Insert the device at an angle into the cable cup until the device touches the bottom of the cup.

**Figure 169** Device Into Cable Cup

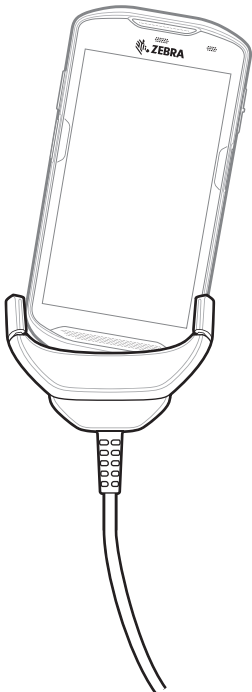

2. Rotate the device into the cup.

**Figure 170** Rotate Device into Cable Cup

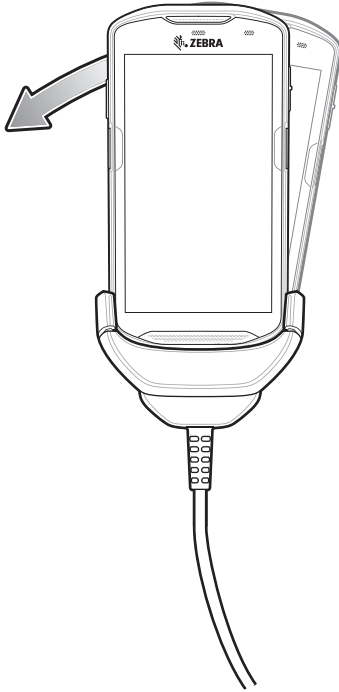

## Connecting to TC57 with Rugged Boot

To connect the Rugged Charge/USB Cable to a device with a Rugged Boot:

1. Using thumb and index finger, squeeze the sides of the cup in.

**Figure 171** Remove Cable Cup Insert

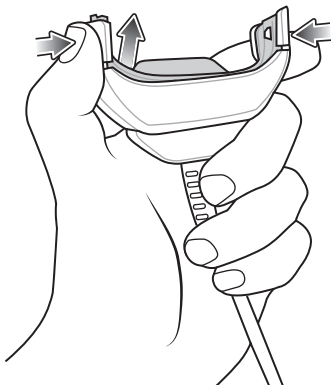

2. Lift inert out of cup.

**Figure 172** Cable Installation

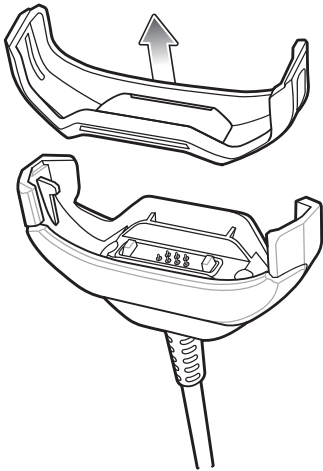

3. Align the cable cup with the bottom of the device.
4. Press the device into the cable cup until it securely in place.

## USB Communication

To connect the device to a host computer:

1. Connect the Rugged Charge/USB Cable to the device.
2. Connect the USB connector of the cable to a host computer.

**Figure 173** Rugged Charge/USB Cable to Host Computer

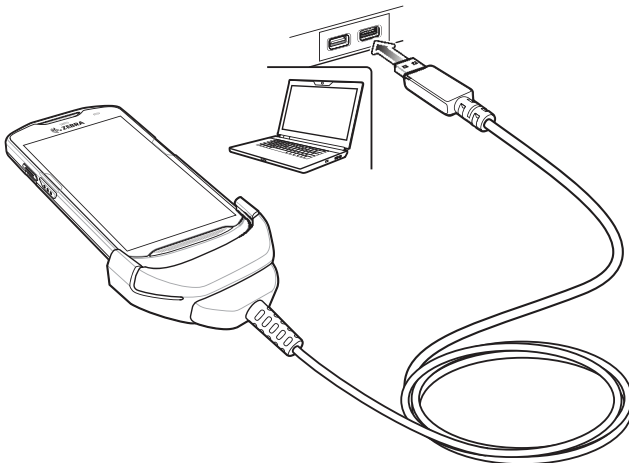

## Charging the Device

To charge the device using the Rugged Charge/USB Cable:

1. Connect the Rugged Charge/USB Cable to the device.



2. Connect the USB connector of the power supply.



**NOTE:** See Power Supply on page 204 for information on setting up the power supply.

By default, the device includes an interface connector. If the interface connector is removed for USB Type C cable connectivity, then it must be replaced before charging or receiving an Ethernet IP address if placed in a cradle.

3. Plug to power supply into an power outlet.

**Figure 174** Charging Using the Rugged Charge/USB Cable

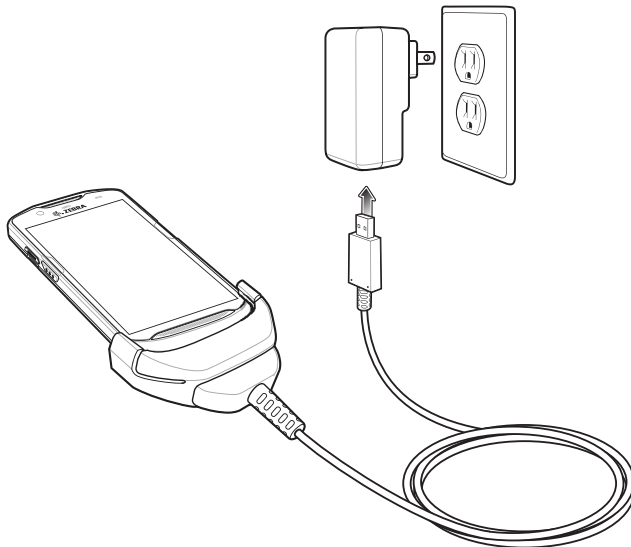

### Disconnecting the Rugged Charge/USB Cable

To disconnect the Rugged Charge/USB Cable from the device:

1. Rotate the device to one side.

**Figure 175** Remove Device from Rugged Charge/USB Cable

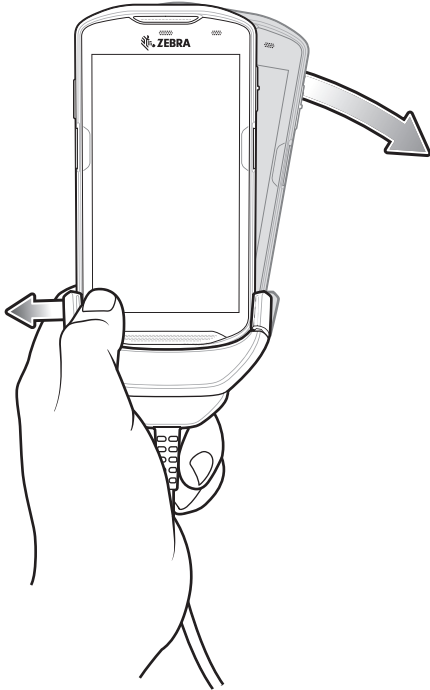

2. Push the Rugged Charge/USB Cable to the other side.
3. Remove the device from the Rugged Charge/USB Cable.

## Battery Charging

### Main Battery Charging

The device's Charging/Notification LED indicates the status of the battery charging in the device. See [Table 3 on page 21](#) for device charging status. The battery charges from fully depleted to 90% in approximately 2.5 hours and from fully depleted to 100% in approximately three hours.



**NOTE:** In many cases the 90% charge provides plenty of charge for daily use. A full 100% charge lasts for approximately 14 hours of use.

To achieve the best fast charging results use only Zebra charging accessories and batteries. Charge batteries at room temperature with the device in sleep mode.

### Main Battery Charging

The device's Charging/Notification LED indicates the status of the battery charging in the device.



**NOTE:** Charging using a host computer USB port or a power supply other than the Zebra PWR-WUA5V12W0xx could take longer. See [Table 13 on page 172](#).

Non-Zebra power supply must provide 5 VDC @ 2.5 A.

The 4,300 mAh (typical) / 4,050 mAh (minimum) battery charges from fully depleted to 90% in approximately 2.5 hours and from fully depleted to 100% in approximately three hours.



**NOTE:** In many cases the 90% charge provides plenty of charge for daily use. A full 100% charge lasts for approximately 14 hours of use.

To achieve the best fast charging results use only Zebra charging accessories and batteries. Charge batteries at room temperature with the device in sleep mode.

### Charging Temperature

Charge batteries in temperatures from 5°C to 40°C (41°F to 104°F). The device or cradle always performs battery charging in a safe and intelligent manner. At higher temperatures (e.g. approximately +37°C (+98°F)) the device or cradle may for small periods of time alternately enable and disable battery charging to keep the battery at acceptable temperatures. The device and cradle indicates when charging is disabled due to abnormal temperatures via its LED.

## Power Supply

Use the power supply with the Rugged Charge/USB Cable to charge the device. The power supply comes in various configuration with different plug adapters for use internationally. To change the plug adapters:

1. Pull the release button down.

**Figure 176** Pull Release Button

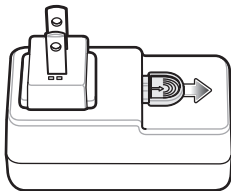

2. Rotate the plug adapter up and out of the power supply.

**Figure 177** Lift Plug Adapter

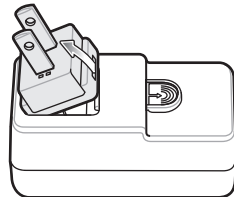

3. Insert the replace plug adapter into the power supply.

**Figure 178** Insert Plug Adapter

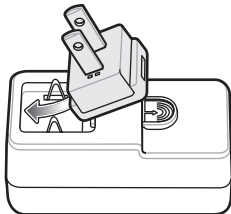

4. Rotate the plug adapter down and snap into place.

**Figure 179** Rotate Plug Adapter in Power Supply

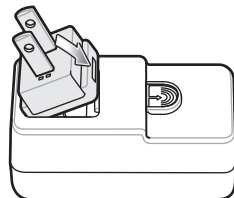

## Trigger Handle



**NOTE:** The Rugged Boot is required to install the Trigger Handle onto the device. Trigger Handle (p/n TRG-TC51-SNP1-01) does not contain the Rugged Boot and must be purchased separately. Trigger Handle Kit (p/n TRG-TC51-TRG1-01) contains the Rugged Boot.

The Trigger Handle adds a gun-style handle with a scanning trigger to the device. It increases comfort when using the device in scan-intensive applications for extended periods of time.

**Figure 180** Trigger Handle

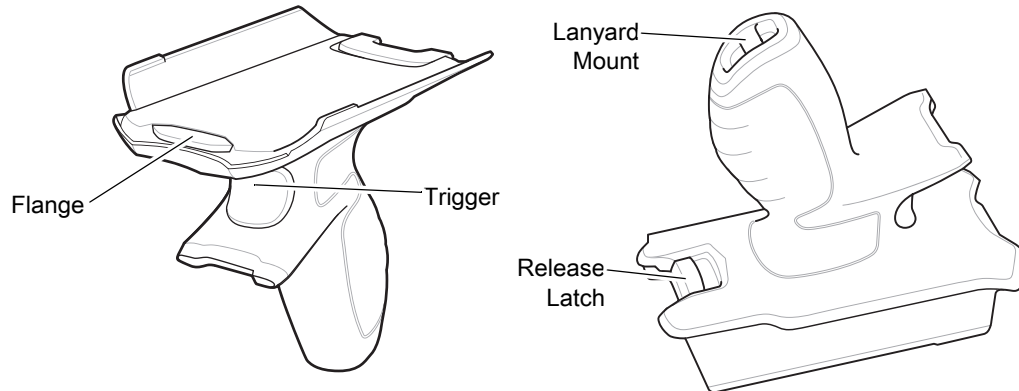

## Installing the Rugged Boot



**NOTE:** If a Hand Strap is attached to the Rugged Boot, remove prior to installing onto device.

To install the Rugged Boot:

1. Insert the bottom of the device into the bottom of the boot.

**Figure 181** Insert Device into Boot

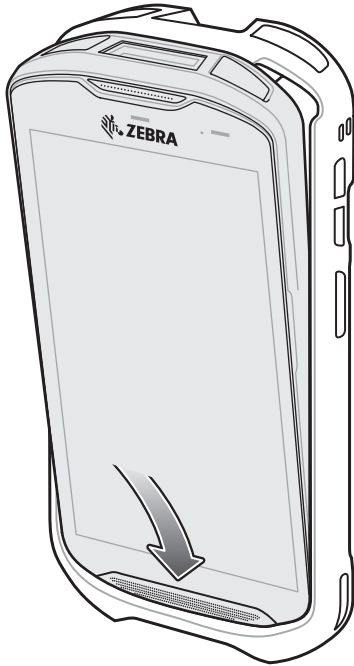

2. Lift the top of the Rugged Boot over the top of the device.

**Figure 182** Lift Boot Over Device



3. Push the device into the Rugged Boot.

**Figure 183** Push Device into Boot

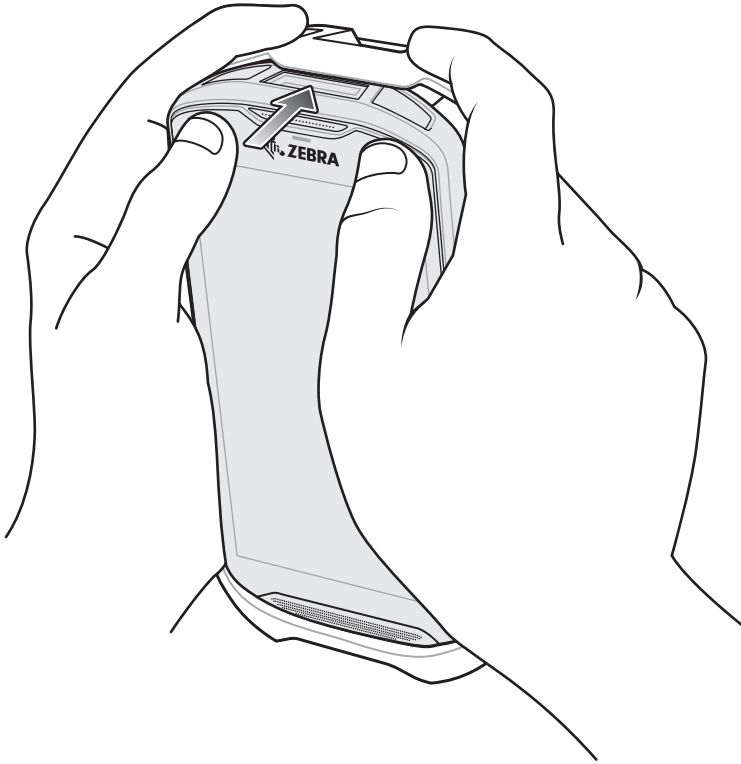

## Installing the Optional Lanyard

To install the lanyard onto the Trigger Handle:

1. Insert the loop end of the tether into the slot on the bottom of the handle.

2. Feed the lanyard through the loop.

**Figure 184** Install Attachment Plate to Handle

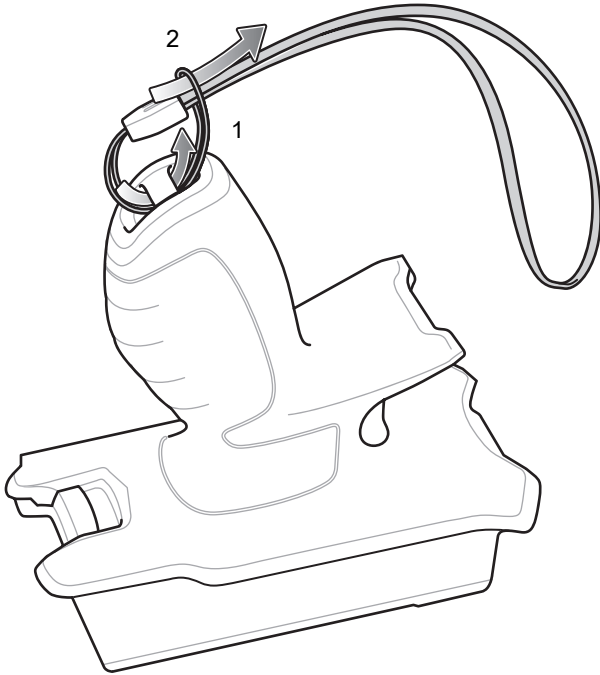

3. Pull the lanyard until the loop tightens.

## Inserting the Device into the Trigger Handle

To install the device onto the Trigger handle:

1. Align and insert the flange of the Trigger Handle with the top of the Rugged Boot.

**Figure 185** Connect Device to Trigger Handle

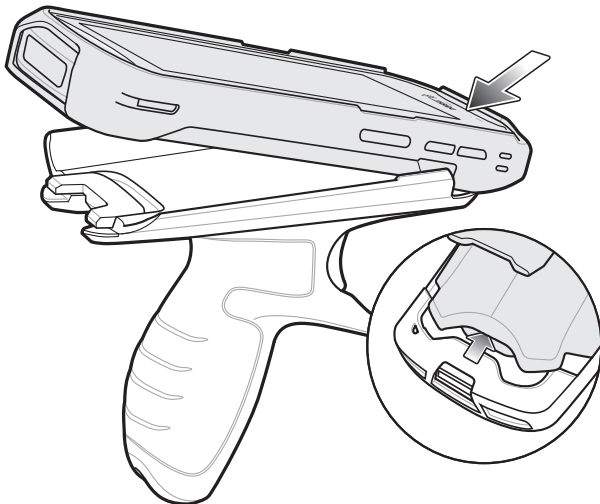



2. Rotate the device down and press down until it snaps into place.

**Figure 186** Rotate Device onto Trigger Handle



## Removing the Device from the Trigger Handle

To remove the device from the Trigger Handle:

1. Press Trigger Handle release latch.

**Figure 187** Press Release Latches

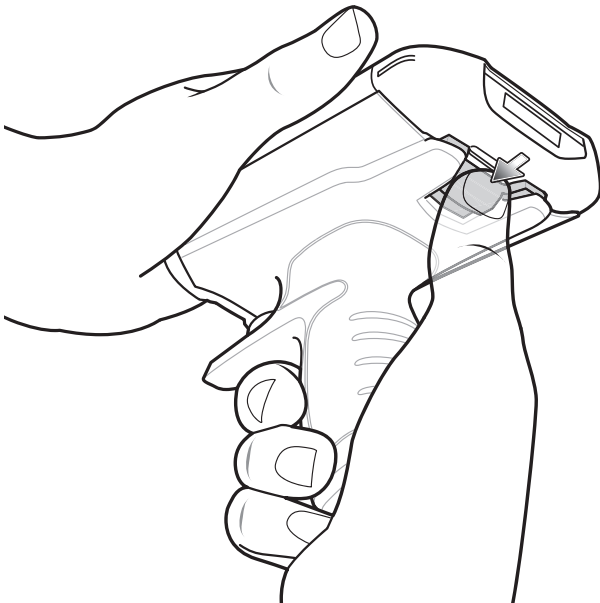

2. Slide the device forward and then rotate the bottom of the device up.

**Figure 188** Remove Device from Trigger Handle

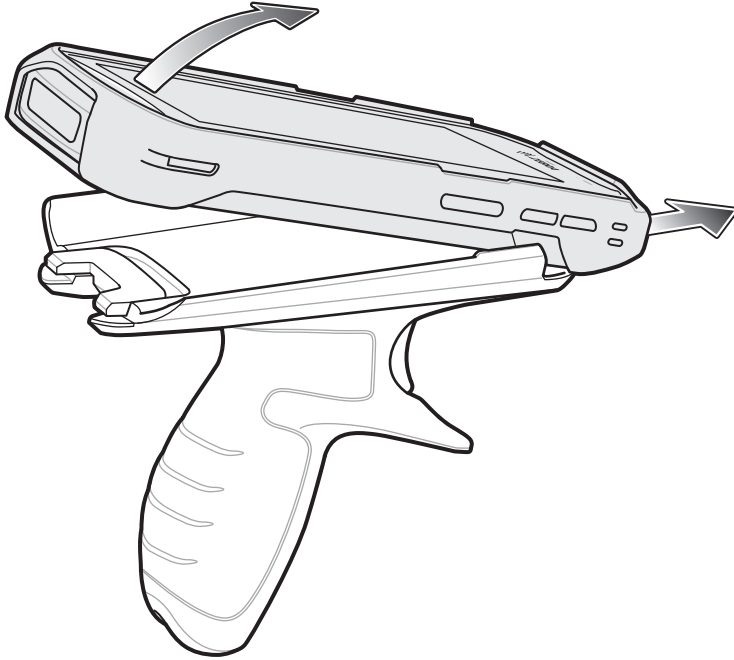

# Maintenance and Troubleshooting

## Introduction

This chapter includes instructions on cleaning and storing the device, and provides troubleshooting solutions for potential problems during operation.

## Maintaining the Device

For trouble-free service, observe the following tips when using the device:

- Do not scratch the screen of the device. When working with the device use the supplied stylus or plastic-tipped pens intended for use with a touch-sensitive screen. Never use an actual pen or pencil or other sharp object on the surface of the device screen.
- The touch-sensitive screen of the device is glass. Do not drop the device or subject it to strong impact.
- Protect the device from temperature extremes. Do not leave it on the dashboard of a car on a hot day, and keep it away from heat sources.
- Do not store or use the device in any location that is dusty, damp, or wet.
- Use a soft lens cloth to clean the device. If the surface of the device screen becomes soiled, clean it with a soft cloth moistened with a diluted window-cleaning solution.
- Periodically replace the rechargeable battery to ensure maximum battery life and product performance. Battery life depends on individual usage patterns.

## Display Best Practices

### Image Retention

Image retention may occur when a static image continuously displays for extended periods of time. A user may see a faint remnant of the image even after a new image displays. To prevent image retention:

- set the display to turn off after a few minutes of idle time.
- rotate background images on a periodic basis.
- turn off the display when the device is not in use.
- use a screen saver with the following characteristics:
  - background color set to black
  - use a small moving image (approximately 2% of the display size).
  - move the image randomly across the screen
  - screen saver should be active as long as the static image is used.

## Battery Safety Guidelines

The area in which the units are charged should be clear of debris and combustible materials or chemicals. Particular care should be taken where the device is charged in a non-commercial environment.

- Follow battery usage, storage, and charging guidelines found in the user's guide.
- Improper battery use may result in a fire, explosion, or other hazard.
- To charge the mobile device battery, the battery and charger temperatures must be between 41°F and +104°F (5°C and +40°C).
- Do not use incompatible batteries and chargers. Use of an incompatible battery or charger may present a risk of fire, explosion, leakage, or other hazard. If you have any questions about the compatibility of a battery or a charger, contact Zebra support.
- For devices that utilize a USB port as a charging source, the device shall only be connected to products that bear the USB-IF logo or have completed the USB-IF compliance program.
- Do not disassemble or open, crush, bend or deform, puncture, or shred.
- Severe impact from dropping any battery-operated device on a hard surface could cause the battery to overheat.
- Do not short circuit a battery or allow metallic or conductive objects to contact the battery terminals.
- Do not modify or remanufacture, attempt to insert foreign objects into the battery, immerse or expose to water or other liquids, or expose to fire, explosion, or other hazard.
- Do not leave or store the equipment in or near areas that might get very hot, such as in a parked vehicle or near a radiator or other heat source. Do not place battery into a microwave oven or dryer.
- Battery usage by children should be supervised.
- Please follow local regulations to promptly dispose of used re-chargeable batteries.
- Do not dispose of batteries in fire.
- Seek medical advice immediately if a battery has been swallowed.
- In the event of a battery leak, do not allow the liquid to come in contact with the skin or eyes. If contact has been made, wash the affected area with large amounts of water and seek medical advice.
- If you suspect damage to your equipment or battery, contact Zebra support to arrange for inspection.

## Cleaning Instructions



**CAUTION:** Always wear eye protection.

Read warning label on alcohol product before using.

If you have to use any other solution for medical reasons please contact the Global Customer Support Center for more information.



**WARNING:** Avoid exposing this product to contact with hot oil or other flammable liquids. If such exposure occurs, unplug the device and clean the product immediately in accordance with these guidelines.

## Approved Cleanser Active Ingredients

100% of the active ingredients in any cleaner must consist of one or some combination of the following: isopropyl alcohol, bleach/sodium hypochlorite<sup>1</sup> (see **important note below**), hydrogen peroxide, ammonium chloride, or mild dish soap.



**IMPORTANT:** Use pre-moistened wipes and do not allow liquid cleaner to pool.

<sup>1</sup>When using sodium hypochlorite (bleach) based products, always follow the manufacturer's recommended instructions:

use gloves during application and remove the residue afterwards with a damp alcohol cloth or a cotton swab to avoid prolonged skin contact while handling the device.

Due to the powerful oxidizing nature of sodium hypochlorite, the metal surfaces on the device are prone to oxidation (corrosion) when exposed to this chemical in the liquid form (including wipes). In the event that these type of disinfectants come in contact with metal on the device, prompt removal with an alcohol-dampened cloth or cotton swab after the cleaning step is critical.

### Harmful Ingredients

The following chemicals are known to damage the plastics on the device and should not come in contact with the device: acetone; ketones; ethers; aromatic and chlorinated hydrocarbons; aqueous or alcoholic alkaline solutions; ethanolamine; toluene; trichloroethylene; benzene; carbolic acid and TB-lysoform.

Many vinyl gloves contain phthalate additives, which are often not recommended for medical use and are known to be harmful to the housing of the device.

### Device Cleaning Instructions

Do not apply liquid directly to the device. Dampen a soft cloth or use pre-moistened wipes. Do not wrap the device in the cloth or wipe, instead gently wipe the unit. Be careful not to let liquid pool around the display window or other places. Before use, allow the unit to air dry.



**NOTE:** For thorough cleaning, it is recommended to first remove all accessory attachments, such as hand straps or cradle cups, from the mobile device and to clean them separately.

### Special Cleaning Notes

The device should not be handled while wearing vinyl gloves containing phthalates, or before hands are washed to remove contaminant residue after gloves are removed.

If products containing any of the harmful ingredients listed above are used prior to handling the device, such as hand sanitizer that contain ethanolamine, hands must be completely dry before handling the device to prevent damage to the device.



**IMPORTANT:** If the battery connectors are exposed to cleaning agents, thoroughly wipe off as much of the chemical as possible and clean with an alcohol wipe. It is also recommended to install the battery in the terminal prior to cleaning and disinfecting the device to help minimize buildup on the connectors.

When using cleaning/disinfectant agents on the device, it is important to follow the directions prescribed by the cleaning/disinfectant agent manufacturer.

### Cleaning Materials Required

- Alcohol wipes
- Lens tissue
- Cotton-tipped applicators
- Isopropyl alcohol
- Can of compressed air with a tube.

### Cleaning Frequency

The cleaning frequency is at the customer's discretion due to the varied environments in which the mobile devices are used and may be cleaned as frequently as required. When dirt is visible, it is recommended to clean the mobile device to avoid build up of particles which make the device more difficult to clean later on.

For consistency and optimum image capture, it is recommended to clean the camera window periodically especially when used in environments prone to dirt or dust.

### Cleaning the Device

#### Housing

Using the alcohol wipes, wipe the housing including buttons.

#### Display

The display can be wiped down with the alcohol wipes, but care should be taken not to allow any pooling of liquid around the edges of the display. Immediately dry the display with a soft, non-abrasive cloth to prevent streaking.

#### Camera and Exit Window

Wipe the camera and exit window periodically with a lens tissue or other material suitable for cleaning optical material such as eyeglasses.

### Connector Cleaning

To clean the connectors:

1. Remove the main battery from mobile computer.
2. Dip the cotton portion of the cotton-tipped applicator in isopropyl alcohol.
3. Rub the cotton portion of the cotton-tipped applicator back-and-forth across the connector. Do not leave any cotton residue on the connector.
4. Repeat at least three times.
5. Use the cotton-tipped applicator dipped in alcohol to remove any grease and dirt near the connector area.
6. Use a dry cotton-tipped applicator and repeat steps 4 through 6.



**CAUTION:** Do not point nozzle at yourself and others, ensure the nozzle or tube is away from your face.

7. Spray compressed air on the connector area by pointing the tube/nozzle about ½ inch away from the surface.
8. Inspect the area for any grease or dirt, repeat if required.

## Cleaning Cradle Connectors

To clean the connectors on a cradle:

1. Remove the DC power cable from the cradle.
2. Dip the cotton portion of the cotton-tipped applicator in isopropyl alcohol.
3. Rub the cotton portion of the cotton-tipped applicator along the pins of the connector. Slowly move the applicator back-and-forth from one side of the connector to the other. Do not leave any cotton residue on the connector.
4. All sides of the connector should also be rubbed with the cotton-tipped applicator.



**CAUTION:** Do not point nozzle at yourself and others, ensure the nozzle or tube is pointed away from your face.

5. Spray compressed air in the connector area by pointing the tube/nozzle about ½ inch away from the surface.
6. Remove any lint left by the cotton-tipped applicator.
7. If grease and other dirt can be found on other areas of the cradle, use a lint-free cloth and alcohol to remove.
8. Allow at least 10 to 30 minutes (depending on ambient temperature and humidity) for the alcohol to air dry before applying power to cradle.

If the temperature is low and humidity is high, longer drying time is required. Warm temperature and dry humidity requires less drying time.

## Troubleshooting

The following tables provides typical problems that might arise and the solution for correcting the problem.

### Device

**Table 16** *Troubleshooting the Device*

Problem	Cause	Solution
When pressing the power button the device does not turn on.	Battery not charged.	Charge or replace the battery in the device.
	Battery not installed properly.	Install the battery properly.
	System crash.	Perform a reset.
When pressing the power button the device does not turn on but two LEDs blink.	Battery charge is at a level where data is maintained but battery should be re-charged.	Charge or replace the battery in the device.
Battery did not charge.	Battery failed.	Replace battery. If the device still does not operate, perform a reset.
	Device removed from cradle while battery was charging.	Insert device in cradle. See <a href="#">Charging the Battery on page 24</a> .
	Extreme battery temperature.	Battery does not charge if ambient temperature is below 0°C (32°F) or above 40°C (104°F).
Cannot see characters on display.	Device not powered on.	Press the <b>Power</b> button.
During data communication with a host computer, no data transmitted, or transmitted data was incomplete.	Device removed from cradle or disconnected from host computer during communication.	Replace the device in the cradle, or reattach the communication cable and re-transmit.
	Incorrect cable configuration.	See the system administrator.
	Communication software was incorrectly installed or configured.	Perform setup.
During data communication over Wi-Fi, no data transmitted, or transmitted data was incomplete.	Wi-Fi radio is not on.	Turn on the Wi-Fi radio.
	You moved out of range of an access point.	Move closer to an access point.



**Table 16** *Troubleshooting the Device (Continued)*

Problem	Cause	Solution
During data communication over Bluetooth, no data transmitted, or transmitted data was incomplete.	Bluetooth radio is not on.	Turn on the Bluetooth radio.
	You moved out of range of another Bluetooth device.	Move within 10 meters (32.8 feet) of the other device.
No sound.	Volume setting is low or turned off.	Adjust the volume.
Device shuts off.	Device is inactive.	The display turns off after a period of inactivity. Set this period to 15 seconds, 30 seconds, 1, 2, 5, 10 or 30 minutes.
	Battery is depleted.	Replace the battery.
Tapping the window buttons or icons does not activate the corresponding feature.	The device is not responding.	Reset the device.
A message appears stating that the device memory is full.	Too many files stored on the device.	Delete unused memos and records. If necessary, save these records on the host computer (or use an SD card for additional memory).
	Too many applications installed on the device.	Remove user-installed applications on the device to recover memory. Select  > <b>Apps</b> . Select the unused application and tap <b>UNINSTALL</b> .
The device does not decode with reading bar code.	Scanning application is not loaded.	Load a scanning application on the device or enable DataWedge. See the system administrator.
	Unreadable bar code.	Ensure the symbol is not defaced.
	Distance between exit window and bar code is incorrect.	Place the device within proper scanning range.
	Device is not programmed for the bar code.	Program the device to accept the type of bar code being scanned. Refer to the EMDK or DataWedge application.
	Device is not programmed to generate a beep.	If the device does not beep on a good decode, set the application to generate a beep on good decode.
	Battery is low.	If the scanner stops emitting a laser beam upon a trigger press, check the battery level. When the battery is low, the scanner shuts off before the device low battery condition notification. Note: If the scanner is still not reading symbols, contact the distributor or the Global Customer Support Center.

**Table 16** *Troubleshooting the Device (Continued)*

Problem	Cause	Solution
Device cannot find any Bluetooth devices nearby.	Too far from other Bluetooth devices.	Move closer to the other Bluetooth device(s), within a range of 10 meters (32.8 feet).
	The Bluetooth device(s) nearby are not turned on.	Turn on the Bluetooth device(s) to find.
	The Bluetooth device(s) are not in discoverable mode.	Set the Bluetooth device(s) to discoverable mode. If needed, refer to the device's user documentation for help.
Cannot unlock device.	User enters incorrect password.	If the user enters an incorrect password eight times, the user is requested to enter a code before trying again. If the user forgot the password, contact system administrator.

# Technical Specifications

## Introduction

The following sections provide technical specification for the device.

## TC57

**Table 17** TC57 Technical Specifications

Item	Description
<b>Physical Characteristics</b>	
Dimensions	Height: 155 mm (6.1 in.) Width: 75.5 mm (2.9 in.) Depth: 18.6 mm (0.73 in.)
Weight	249 g (8.8 oz) with battery
Display	5.0 in. High Definition (1280 x 720); exceptionally bright, outdoor viewable; optically bonded to touch panel
Touch Panel	Dual mode capacitive touch with stylus or bare or gloved fingertip input (conductive stylus sold separately); Corning Gorilla Glass; water droplet rejection; fingerprint resistant anti-smudge coating.
Backlight	Light Emitting Diode (LED) backlight
Battery	Rechargeable Li-Ion, 4,150 mAh, 4.4 volts Power Precision+ with improved battery technology for longer cycle times and real-time visibility into battery metrics for better battery management. Fast USB charging up to 2.4 A.
Expansion Slot	User accessible MicroSD up to 32 GB SDHC and up to 256 GB SDXC, using FAT32 format.
Connection Interface	Universal Serial Bus (USB) 2.0 High Speed (host and client)
Network Connections	WLAN, WPAN (Bluetooth)
Notification	Audible tone, multi-color LEDs, and vibration.
Keypad	On-screen keyboard.
Voice and Audio	Three microphones with noise cancellation; vibrate alert; speaker; Bluetooth wireless headset support. High quality speaker phone; PTT headset support; Cellular circuit switch voice; HD Voice and SWB & FB audio.

## Technical Specifications

**Table 17** TC57 Technical Specifications (Continued)

Item	Description
Buttons	Programmable back button; dual dedicated scan buttons; dedicated push-to-talk button, and volume up/down buttons
<b>Performance Characteristics</b>	
CPU	Qualcomm Snapdragon 660 octa-core, 2.2 GHz.
Operating System	Android 8.1.0 Oreo with Zebra's Restricted Mode for control over GMS and other services.
Memory	4 GB RAM/32 GB Flash
Output Power	USB - 5 VDC @ 500 mA max
<b>User Environment</b>	
Operating Temperature	-20°C to 50°C (-4°F to 122°F)
Relative Humidity	Operating: 5 to 95% non-condensing
Storage Temperature	-40°C to 70°C (-40°F to 158°F)
Charging Temperature	0° C to 40° C (32°F to 104°F)
Humidity	5 to 85% non-condensing
Drop Specification	Multiple 1.2 m (4 ft.) to tile over concrete over -10°C to 50°C (14°F to 122°F). Multiple 1.8 m (6 ft.) drops to concrete with Rugged Boot per Mil Std 810 G.
Tumble	500 0.5 m (1.6 ft.) tumbles; meets and exceeds IEC tumble specifications
Sealing	IP67 and IP65 per applicable IEC sealing specifications
Electrostatic Discharge (ESD)	±15 kVDC air discharge, ±8 kVDC direct discharge, ± 8 kVDC indirect discharge
Vibration	4 g's PK Sine (5 Hz to 2 kHz); 0.04g2/Hz Random (20 Hz to 2 kHz); 60 minute duration per axis, 3 axis
Thermal Shock	-40°C to 70°C (-40°F to 158°F) rapid transition
<b>Interactive Sensor Technology (IST)</b>	
Motion Sensor	3-axis accelerometer with MEMS Gyro
Light Sensor	Automatically adjusts display backlight brightness
Proximity Sensor	Automatically detects when the user places the handset against head during a phone call to disable display output and touch input.
Pressure Sensor	Automatically detects altitude information for locationing.
Magnetometer	eCompass automatically detects direction and orientation.

## Technical Specifications

**Table 17** TC57 Technical Specifications (Continued)

Item	Description
<b>Wireless WAN Data and Voice Communications</b>	
Radio Frequency Band	Supports VoLTE , Carrier Aggregation up to 3DL CA LTE FDD: 700/800/850/900/1800/1900/AWS/2100/2600 (28,13,14,12,17/19,20/5,26/8/3/2,25/4,66/1/7); LTE TDD: 1900/2300/2500 (39/40/41,38); UMTS/HSPA/HSPA+: 850/900/AWS/1900/2100 (5/8/4/2/1); GSM/GPRS/EDGE: 850/900/1800/1900
GPS	Autonomous, Assisted GPS (A-GPS); Navstar; GLONASS; Galileo; BeiDou
<b>Wireless LAN Data and Voice Communications</b>	
Radio	IEEE 802.11a/b/g/n/ac/d/h/i/k/r/v/w; Wi-Fi™ certified; IPv4, IPv6; 2X2 MU-MIMO
Data Rates Supported	5GHz: 802.11a/n/ac - up to 866.7 Mbps 2.4GHz: 802.11b/g/n - up to 300 Mbps
Operating Channels	Chan 1 - 13 (2412 - 2472 MHz) Chan 36 - 165 (5180 - 5825 MHz) Channel Bandwidth: 20, 40, 80 MHz Actual operating channels/frequencies depend on regulatory rules and certification agency
Security and Encryption	WEP (40 or 104 bit); WPA/WPA2 Personal (TKIP, and AES); WPA/WPA2 Enterprise (TKIP and AES) — EAP-TTLS (PAP, MSCHAP, MSCHAPv2), EAP-TLS, PEAPv0-MSCHAPv2, PEAPv1-EAP-GTC and LEAP.EAP-PWD Data in Motion: FIPS 140-2 Level 1 Data at Rest: FIPS 140-2 Level 1
Certifications	WFA (802.11n, WMM-PS, 802.11r; PMF)
Fast Roam	PMKID caching; Cisco CCKM; 802.11r; OKC
<b>Wireless PAN Data and Voice Communications</b>	
Bluetooth	Class 2, Bluetooth v5.0, Bluetooth Low Energy (BLE)
<b>Data Capture Specifications</b>	
Scanning	SE4710 imager (1D and 2D) with LED aimer.
Camera	Front — 5 MP; f/2.0 aperture front facing camera. Rear — 13 MP autofocus; f/2.2 aperture; rear camera flash LED generates balanced white light; supports Torch mode; 4K video with image stabilization.
Near Field Communications (NFC)	ISO 14443 Type A and B; F; FeliCa and ISO 15693 cards; P2P mode and Card Emulation via Host
<b>2D Imager Engine (SE4710) Specifications</b>	
Field of View	Horizontal - 48.0° Vertical - 36.7°
Image Resolution	1280 horizontal X 960 vertical pixels

**Table 17** TC57 Technical Specifications (Continued)

Item	Description
Roll	360°
Pitch Angle	+/- 60° from normal
Skew Tolerance	+/- 60° from normal
Ambient Light	Sunlight: 10,000 ft. candles (107,639 lux)
Focal Distance	From front of engine: 17.7 cm (7.0 in.)
Laser Aiming Element	Visible Laser Diode (VLD): 655 nm +/- 10 nm Central Dot Optical Power: 0.6 mW (typical) Pattern Angle: 48.0° horizontal, 38.0° vertical
Illumination System	LEDs: Warm white LED Pattern Angle: 80° at 505 intensity

**Table 18** Data Capture Supported Symbologies

Item	Description
1D Bar Codes	Code 128, EAN-8, EAN-13, GS1 DataBar Expanded, GS1 128, GS1 DataBar Coupon, UPCA, Interleaved 2 of 5, UPC Coupon Code
2D Bar Codes	PDF-417, QR Code

# Index

## Numerics

## Numerics

1-slot USB/charge only cradle kit	172
4-slot battery charger kit	173
4-slot charge only cradle with battery charger kit	172
5-slot charge only cradle kit	172
5-slot Ethernet cradle kit	172

## A

ActiveEdge touch zone	79
configuring	79
selecting apps for a drawer	80
adaptive frequency hopping	166
adjust volume	68
airplane mode	32
alarms only	53
albums	108, 114
deleting	109, 115
getting information	108
sharing	108, 115
working with	108
working with albums	114
ambient display setting	36
apn	161
approved cleanser	212
approved cleanser active ingredients	212
apps	55
accessing	58
ActiveEdge touch zone	79
adding shortcuts	49
battery manager	82
camera	86
datawedge demonstration	96
device central	93
diagnostic tool	98
files	104
Gallery	106
photos	113
PTT Express	119

RxLogger	123
RxLogger Utility	124
shortcuts	49
SimulScan Demo	125
sound recorder	134
audio adapter	173
audio modes	67
automatically block sounds and vibrations	54

## B

barcode scanning	
digital camera	136
DS3678 Digital Scanner	139
DS3678 digital scanner	139
basic hand strap	174
battery	18, 172
low battery notification	32
monitor usage	31
battery charging	24
battery management	31
battery level	31
battery present status	31
battery manager	82
battery optimization	32
battery swap	26
Bluetooth	156
bluetooth	165
change name	169
disabling	168
discovering devices	168
enabling	168
PIN	166
power states	168
profiles	167
security	166
Bluetooth call	75

## C

call forwarding	77
call waiting	77

- caller ID ..... 77
  - camera ..... 18, 56, 86
    - front camera photo settings ..... 89
    - front camera video settings ..... 90
    - photo settings ..... 89
    - rear camera photo settings ..... 89
    - rear camera video settings ..... 91
    - recording videos ..... 88
    - taking panoramic photos ..... 87
    - taking photos ..... 86
    - video settings ..... 90
  - camera settings ..... 89, 90
  - cast ..... 37
  - change bluetooth name ..... 169
  - cleaning ..... 212, 213
    - frequency ..... 214
    - instructions ..... 212
  - cleaning instructions ..... 213
  - conference call ..... 73
  - connect to WLAN ..... 164
  - contacts ..... 91
    - adding ..... 91
    - deleting ..... 92
    - editing ..... 91
  - cradle
    - connector cleaning ..... 215
  - cradle mount ..... 172
- D**
- data capture
    - digital camera ..... 136
    - DS3678 Digital Scanner ..... 139
    - DS3678 digital scanner ..... 139
  - datawedge ..... 154
    - disable ..... 155
    - enable ..... 154
  - datawedge demonstration ..... 96
  - DC line cord ..... 175
  - device central ..... 93
    - paging an RS6000 ring scanner ..... 94
    - tabs ..... 94
  - device settings
    - accessing ..... 30
  - diagnostic tool ..... 98
    - battery test information ..... 101
    - bluetooth test information ..... 103
    - gps test information ..... 102
    - settings ..... 101
    - system test information ..... 102
    - wlan test information ..... 102
    - wwan test information ..... 102
  - digital camera ..... 136
    - barcode scanning ..... 136
    - data capture ..... 136
  - disable bluetooth ..... 168
  - disconnect host computer ..... 65
  - discover bluetooth devices ..... 168
  - display
    - cleaning ..... 214
  - display settings ..... 33
  - do not disturb feature ..... 53
  - DS3678
    - pairing ..... 152
    - pairing using Bluetooth HID ..... 154
    - pairing using simple serial interface ..... 152
    - scanning ..... 146
  - DS3678 Digital Scanner
    - barcode scanning ..... 139
    - data capture ..... 139
  - DS3678 digital scanner
    - barcode scanning ..... 139
    - data capture ..... 139
- E**
- EAP ..... 164
  - edit apn ..... 161
  - emergency calling ..... 67
  - enable bluetooth ..... 168
  - Ethernet connection ..... 188
- F**
- feature ..... 17
  - feedback ..... 15
  - file transfer ..... 64
  - files ..... 104
  - finger usage ..... 36
  - folders ..... 50
    - creating ..... 50
    - naming ..... 50
    - removing ..... 51
  - font size ..... 35
- G**
- Gallery ..... 106
    - cropping photos ..... 110
    - deleting albums ..... 109
    - deleting photos ..... 111
    - deleting videos ..... 112
    - getting album information ..... 108
    - setting photos as contact icons ..... 110
    - sharing albums ..... 108
    - sharing photos ..... 111
    - sharing videos ..... 111
    - viewing photos ..... 109
    - watching videos ..... 111
    - working with albums ..... 108



working with photos .....	109
working with videos .....	111
general sound setting .....	37
google	
account setup .....	25
mobile services .....	41

## H

hand strap .....	174
handset mode .....	67
hands-free imager .....	138
hard reset .....	64
harmful ingredients .....	213
headset jack .....	19
headset mode .....	67
home screen .....	41
moving items .....	50
rotation .....	34
home screen wallpaper .....	51

## I

install microsd card .....	22
----------------------------	----

## K

keyboards	
configuration .....	52
entering numbers, symbols, and special characters .	52

## L

light sensor .....	17
linear imager .....	137
lock screen notifications .....	47
low battery notification .....	32

## M

maintenance	
approved cleanser active ingredients .....	212
cleaning frequency .....	214
cleaning instructions .....	212
device cleaning instructions .....	213
harmful ingredients .....	213
special cleaning notes .....	213
managing notifications .....	45
messaging .....	57
microSD card .....	22, 27
monitor battery usage .....	31

## N

near field communication .....	156
near field communications .....	169
NFC .....	169
NFC antenna .....	18
notational conventions .....	13
notification icons .....	44
notifications	
lock screen .....	47
managing .....	45

## P

pairing	
DS3678 .....	152
using Bluetooth HID(DS3678) .....	154
using simple serial interface (DS3678) .....	152
panoramic .....	87
photo transfer .....	65
photos .....	113
camera settings .....	89
cropping .....	110, 116
deleting .....	111, 118
deleting albums .....	115
deleting videos .....	118
panoramic .....	87
setting as contact icons .....	110, 117
sharing .....	111, 117
sharing albums .....	115
sharing videos .....	118
taking .....	86
viewing .....	109
viewing and browsing .....	116
watching videos .....	118
working with .....	109
working with albums .....	114
working with photos .....	116
working with videos .....	118
picklist .....	137
power supply .....	174
proximity sensor .....	17
PTT button .....	18
PTT Express	
audible indicators .....	119
disabling communication .....	122
enabling communication .....	121
group calls .....	121
notification icons .....	119
private response .....	122
talk groups .....	121
Voice Client .....	119
PTT-Express	
PTT communication .....	121

## Q

quick access panel	47
quick settings	
edit icons	48

## R

remove wi-fi	165
reset device	
hard reset	64
resetting the device	63
resetting	63
ringtone	77
RS507	
scanning	144
RS507 scanning	144, 146, 147
RS6000	
bluetooth ring scanner	138
scanning	143
RS6000 scanning	143
rugged boot	174
rugged charge/USB cable	173
RxLogger	123
RxLogger Utility	124

## S

scan button	18
scanning	140, 142
considerations	140
DS3678	146
RS507	144
RS6000	143
screen font size	35
screen rotation	34
security	164
setting	
camera	89, 90
notification LED	37
wakeup sources	39
settings	
accessing	30
ambient display	36
automatically block sounds and vibrations	54
camera photos	89
camera videos	90
display	33
do not disturb	53
general sound	37
home screen wallpaper	51
limit sounds and vibrations	53
override do not disturb for specific apps	55
SIM card	28
SimulScan Demo	125

advanced settings	131
creating a demo customization	132
default templates	134
printing sample forms	126
settings	131
using the manufacturing example	129
using the postal, transportation and logistics example	127
SMS	57
soft holster	174
soft reset	63
software version	13
software versions	13
sound recorder	134
speaker	17
speaker mode	67
status bar	43
stylus	174
symbolologies	222

## T

taking a panoramic photo	87
touch mode	36
transferring files using USB	64
trigger handle	174
trigger handle kit	174
troubleshooting	216
TTY	77

## U

USB	64
using a wired headset	67
using the dialer	68

## V

videos	
camera settings	90
deleting	112, 118
recording	88
sharing	111, 118
watching	111, 118
working with	111
working with videos	118
voicemail setup	77

## W

wakeup sources	39
WEP	164
widgets	49
adding	49
wi-fi network	164

wired headset .....67  
wireless local area network .....156  
wireless wide area network .....156  
WLAN .....156  
WPA .....164  
WWAN .....156

